

Protection from Short-circuit

**Back-up Fuse-Link with ÜLA
(controlled power dissipation)**



Test device for tripping device



Special version with thread



**High-voltage Fuse-Link for
voltage transformers (HSW)**



Content

High Voltage Fuse-Links and Accessories

High Voltage Fuse-Links acc. to VDE 0670 T402/IEC 60 282-1	356
High Voltage Fuse-Links acc. to VDE 0670 T4/IEC 60 282-1	358
HV Fuses for Voltage Transformers	361
Accessories	362
Technical data	see page 364
Selection table acc. to T402	371
Selection table acc. to T4	372



System

The range of general purpose and back-up High Voltage Fuse-Links by EFEN is nationally and internationally approved. The Fuse-Links allow reliable protection for transformers, condensers and engines.

Features

The portfolio of HH Fuse-Links includes various types for indoor, outdoor and oil-submerged applications. Many different Fuse-Links, for example in special dimensions, as well as a wide range of accessories round up the portfolio.

Accessories

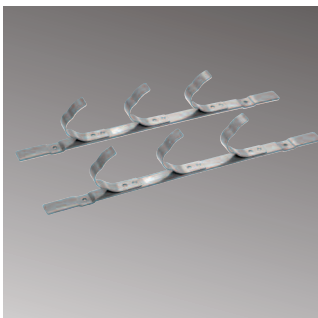

Fuse-Base contacts

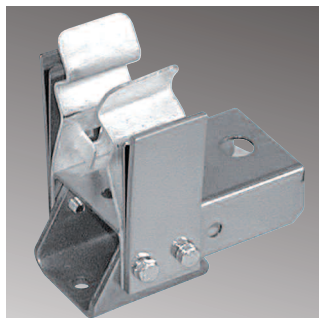

High Voltage Fuse-Links

For more information
see page 364



67140-1000

HV back-up Fuse-Links according to VDE 0670 T402 / IEC 60 282-1

Description	Rated voltage kV	Length	Ø	Amps	Order-No.	PU	PG	Sur. Ag	Sur. Cu	Price €/pc.
HH-SI 3/7,2KV 6,3A FC TA 192/56	3/7,2	192	56	6,3	67110-0060	1	HH 1	0,019	0,012	65,70
HH-SI 3/7,2KV 10A FC TA 192/56	3/7,2	192	56	10	67110-0100	1	HH 1	0,026	0,012	65,70
HH-SI 3/7,2KV 16A FC TA 192/56	3/7,2	192	56	16	67110-0160	1	HH 1	0,020	0,012	65,70
HH-SI 3/7,2KV 20A FC TA 192/56	3/7,2	192	56	20	67110-0200	1	HH 1	0,022	0,012	65,70
HH-SI 3/7,2KV 25A FC TA 192/56	3/7,2	192	56	25	67110-0250	1	HH 1	0,025	0,012	67,90
HH-SI 3/7,2KV 31,5A FC TA 192/56	3/7,2	192	56	31,5	67110-0320	1	HH 1	0,028	0,012	70,00
HH-SI 3/7,2KV 40A FC TA 192/56	3/7,2	192	56	40	67110-0400	1	HH 1	0,033	0,012	94,70
HH-SI 3/7,2KV 50A FC TA 192/56	3/7,2	192	56	50	67110-0500	1	HH 1	0,038	0,012	95,80
HH-SI 3/7,2KV 63A FC TA 192/65	3/7,2	192	65	63	67110-0630	1	HH 1	0,053	0,014	101,25
HH-SI 3/7,2KV 80A FC TA 192/65	3/7,2	192	65	80	67110-0800	1	HH 1	0,063	0,014	101,25
HH-SI 3/7,2KV 100A FC TA 192/78	3/7,2	192	78	100	67110-1000	1	HH 1	0,084	0,017	107,70
HH-SI 3/7,2KV 125A FC TA 192/88	3/7,2	192	88	125	67110-1250	1	HH 1	0,111	0,020	112,00
HH-SI 3/7,2KV 160A FC TA 192/88	3/7,2	192	88	160	67110-1600	1	HH 1	0,161	0,020	131,45
HH-SI 6/12KV 6,3A FC TA 292/56	6/12	292	56	6,3	67120-0060	1	HH 1	0,022	0,012	71,05
HH-SI 6/12KV 10A FC TA 292/56	6/12	292	56	10	67120-0100	1	HH 1	0,033	0,012	71,05
HH-SI 6/12KV 16A FC TA 292/56	6/12	292	56	16	67120-0160	1	HH 1	0,024	0,012	71,05
HH-SI 6/12KV 20A FC TA 292/56	6/12	292	56	20	67120-0200	1	HH 1	0,028	0,012	71,05
HH-SI 6/12KV 25A FC TA 292/56	6/12	292	56	25	67120-0250	1	HH 1	0,032	0,012	73,25
HH-SI 6/12KV 31,5A FC TA 292/56	6/12	292	56	31,5	67120-0320	1	HH 1	0,036	0,012	75,35
HH-SI 6/12KV 40A FC TA 292/56	6/12	292	56	40	67120-0400	1	HH 1	0,046	0,012	98,00
HH-SI 6/12KV 50A FC TA 292/56	6/12	292	56	50	67120-0500	1	HH 1	0,054	0,012	101,25
HH-SI 6/12KV 63A FC TA 292/65	6/12	292	65	63	67120-0630	1	HH 1	0,077	0,014	108,80
HH-SI 6/12KV 80A FC TA 292/65	6/12	292	65	80	67120-0800	1	HH 1	0,094	0,014	108,80
HH-SI 6/12KV 100A FC TA 292/78	6/12	292	78	100	67120-1000	1	HH 1	0,126	0,017	112,00
HH-SI 6/12KV 125A FC TA 292/88	6/12	292	88	125	67120-1250	1	HH 1	0,178	0,020	119,50
HH-SI 6/12KV 160A FC TA 292/88	6/12	292	88	160	67120-1600	1	HH 1	0,252	0,020	142,30
HH-SI 10/17,5KV 6,3A FC TA 367/56	10/17,5	367	56	6,3	67130-0060	1	HH 1	0,025	0,012	74,30
HH-SI 10/17,5KV 10A FC TA 367/56	10/17,5	367	56	10	67130-0100	1	HH 1	0,039	0,012	74,30
HH-SI 10/17,5KV 16A FC TA 367/56	10/17,5	367	56	16	67130-0160	1	HH 1	0,029	0,012	74,30
HH-SI 10/17,5KV 20A FC TA 367/56	10/17,5	367	56	20	67130-0200	1	HH 1	0,034	0,012	74,30
HH-SI 10/17,5KV 25A FC TA 367/56	10/17,5	367	56	25	67130-0250	1	HH 1	0,040	0,012	78,60
HH-SI 10/17,5KV 30A FC TB 367/56	10/17,5	367	56	30	67130-0300	1	HH 1	0,047	0,012	78,60
HH-SI 10/17,5KV 31,5A FC TA 367/56	10/17,5	367	56	31,5	67130-0320	1	HH 1	0,047	0,012	81,75
HH-SI 10/17,5KV 40A FC TA 367/56	10/17,5	367	56	40	67130-0400	1	HH 1	0,084	0,017	102,30
HH-SI 10/17,5KV 50A FC TA 367/78	10/17,5	367	78	50	67130-0500	1	HH 1	0,109	0,017	116,30
HH-SI 10/17,5KV 63A FC TA 367/78	10/17,5	367	78	63	67130-0630	1	HH 1	0,133	0,017	119,50
HH-SI 10/17,5KV 80A FC TA 367/78	10/17,5	367	78	80	67130-0800	1	HH 1	0,179	0,017	122,60
HH-SI 10/17,5KV 100A FC TA 367/88	10/17,5	367	88	100	67130-1000	1	HH 1	0,179	0,020	126,80
HH-SI 10/24KV 6,3A FC TA 442/56	10/24	442	56	6,3	67140-0060	1	HH 1	0,027	0,012	79,65
HH-SI 10/24KV 10A FC TA 442/56	10/24	442	56	10	67140-0100	1	HH 1	0,044	0,012	79,65
HH-SI 10/24KV 16A FC TA 442/56	10/24	442	56	16	67140-0160	1	HH 1	0,034	0,012	79,65
HH-SI 10/24KV 20A FC TA 442/56	10/24	442	56	20	67140-0200	1	HH 1	0,041	0,012	79,65
HH-SI 10/24KV 25A FC TA 442/56	10/24	442	56	25	67140-0250	1	HH 1	0,050	0,012	105,55
HH-SI 10/24KV 31,5A FC TA 442/56	10/24	442	56	31,5	67140-0320	1	HH 1	0,059	0,012	108,70
HH-SI 10/24KV 40A FC TA 442/56	10/24	442	56	40	67140-0400	1	HH 1	0,076	0,012	112,00
HH-SI 10/24KV 50A FC TA 442/65	10/24	442	65	50	67140-0500	1	HH 1	0,109	0,017	124,90
HH-SI 10/24KV 63A FC TA 442/65	10/24	442	65	63	67140-0630	1	HH 1	0,142	0,017	125,00
HH-SI 10/24KV 80A FC TA 442/65	10/24	442	65	80	67140-0800	1	HH 1	0,175	0,017	133,50
HH-SI 10/24KV 100A FC TA 442/88	10/24	442	88	100	67140-1000	1	HH 1	0,237	0,020	139,00
HH-SI 20/36KV 6,3A FC TA 537/56	20/36	537	56	6,3	67150-0060	1	HH 1	0,030	0,012	90,45
HH-SI 20/36KV 10A FC TA 537/56	20/36	537	56	10	67150-0100	1	HH 1	0,052	0,012	90,45
HH-SI 20/36KV 16A FC TA 537/56	20/36	537	56	16	67150-0160	1	HH 1	0,044	0,012	90,45
HH-SI 20/36KV 20A FC TA 537/56	20/36	537	56	20	67150-0200	1	HH 1	0,054	0,012	90,45
HH-SI 20/36KV 25A FC TA 537/56	20/36	537	56	25	67150-0250	1	HH 1	0,064	0,012	137,30

High Voltage Fuse-Links

For more information
see page 364

HV back-up Fuse-Links according to VDE 0670 T402 / IEC 60 282-1

Description	Rated voltage kV	Length	Ø	Amps	Order-No.	PU	PG	Sur. Ag	Sur. Cu	Price €/pc.
HH-SI 20/36KV 31,5A FC TA 537/65	20/36	537	65	31,5	67150-0320	1	HH 1	0,086	0,014	141,50
HH-SI 20/36KV 40A FC TA 537/65	20/36	537	65	40	67150-0400	1	HH 1	0,106	0,014	152,00
HH-SI 20/36KV 50A FC TA 537/88	20/36	537	88	50	67150-0500	1	HH 1	0,156	0,020	155,00
HH-SI 20/36KV 63A FC TA 537/88	20/36	537	88	63	67150-0630	1	HH 1	0,183	0,020	160,00



67141-1000

HV back-up Fuse-Links according to VDE 0670 T402 / IEC 60 282-1, with controlled power dissipation (ÜLA)

Description	Rated voltage kV	Length	Ø	Amps	Order-No.	PU	PG	Sur. Ag	Sur. Cu	Price €/pc.
HH-SI 6/12KV 10A FC ÜLA 292/56	6/12	292	56	10	67520-0100	1	HH 1	0,033	0,012	75,35
HH-SI 6/12KV 16A FC ÜLA 292/56	6/12	292	56	16	67520-0160	1	HH 1	0,030	0,012	75,35
HH-SI 6/12KV 20A FC ÜLA 292/56	6/12	292	56	20	67520-0200	1	HH 1	0,033	0,012	75,35
HH-SI 6/12KV 25A FC ÜLA 292/56	6/12	292	56	25	67520-0250	1	HH 1	0,037	0,012	78,60
HH-SI 6/12KV 31,5A FC ÜLA 292/56	6/12	292	56	31,5	67520-0320	1	HH 1	0,042	0,012	81,85
HH-SI 6/12KV 40A FC ÜLA 292/56	6/12	292	56	40	67520-0400	1	HH 1	0,051	0,012	103,00
HH-SI 6/12KV 50A FC ÜLA 292/56	6/12	292	56	50	67520-0500	1	HH 1	0,059	0,012	104,30
HH-SI 6/12KV 63A FC ÜLA 292/65	6/12	292	65	63	67520-0630	1	HH 1	0,083	0,014	108,80
HH-SI 6/12KV 80A FC ÜLA 292/65	6/12	292	65	80	67520-0800	1	HH 1	0,099	0,014	113,00
HH-SI 6/12KV 100A FC ÜLA 292/65	6/12	292	65	100	67520-1000	1	HH 1	0,101	0,014	117,00
HH-SI 6/12KV 125A FC ÜLA 292/88	6/12	292	88	125	67520-1250	1	HH 1	0,178	0,020	123,00
HH-SI 6/12KV 160A FC ÜLA 292/88	6/12	292	88	160	67520-1600	1	HH 1	0,252	0,020	147,00
HH-SI 10/24KV 6,3A FC ÜLA 442/56	10/24	442	56	6,3	67541-0060	1	HH 1	0,026	0,012	84,00
HH-SI 10/24KV 10A FC ÜLA 442/56	10/24	442	56	10	67541-0100	1	HH 1	0,044	0,012	84,00
HH-SI 10/24KV 16A FC ÜLA 442/56	10/24	442	56	16	67541-0160	1	HH 1	0,044	0,012	84,00
HH-SI 10/24KV 20A FC ÜLA 442/56	10/24	442	56	20	67541-0200	1	HH 1	0,051	0,012	84,00
HH-SI 10/24KV 25A FC ÜLA 442/56	10/24	442	56	25	67541-0250	1	HH 1	0,059	0,012	109,00
HH-SI 10/24KV 31,5A FC ÜLA 442/56	10/24	442	56	31,5	67541-0320	1	HH 1	0,068	0,012	115,00
HH-SI 10/24KV 40A FC ÜLA 442/56	10/24	442	56	40	67541-0400	1	HH 1	0,085	0,012	117,00
HH-SI 10/24KV 50A FC ÜLA 442/65	10/24	442	65	50	67541-0500	1	HH 1	0,117	0,014	128,00
HH-SI 10/24KV 63A FC ÜLA 442/65	10/24	442	65	63	67541-0630	1	HH 1	0,133	0,014	130,00
HH-SI 10/24KV 80A FC ÜLA 442/65	10/24	442	65	80	67541-0800	1	HH 1	0,187	0,014	137,00
HH-SI 10/24KV 100A FC ÜLA 442/88	10/24	442	88	100	67541-1000	1	HH 1	0,237	0,020	142,00
HH-SI 20/36KV 6,3A FC ÜLA 537/56	20/36	537	56	6,3	67550-0060	1	HH 1	0,047	0,012	94,70
HH-SI 20/36KV 10A FC ÜLA 537/56	20/36	537	56	10	67550-0100	1	HH 1	0,070	0,012	94,70
HH-SI 20/36KV 16A FC ÜLA 537/56	20/36	537	56	16	67550-0160	1	HH 1	0,061	0,012	94,70
HH-SI 20/36KV 20A FC ÜLA 537/56	20/36	537	56	20	67550-0200	1	HH 1	0,072	0,012	94,70
HH-SI 20/36KV 25A FC ÜLA 537/56	20/36	537	56	25	67550-0250	1	HH 1	0,082	0,012	141,00
HH-SI 20/36KV 31,5A FC ÜLA 537/65	20/36	537	65	31,5	67550-0320	1	HH 1	0,104	0,014	152,00
HH-SI 20/36KV 40A FC ÜLA 537/65	20/36	537	65	40	67550-0400	1	HH 1	0,124	0,014	155,00
HH-SI 20/36KV 50A FC ÜLA 537/88	20/36	537	88	50	67550-0500	1	HH 1	0,174	0,020	160,00

High Voltage Fuse-Links

For more information
see page 364



67420-0060

EFEN HV general purpose Fuse-Links

Description	Rated voltage kV	Length	Ø	Amps	Order-No.	PU	PG	Sur. Ag	Sur. Cu	Price €/pc.
HH-SI 6/12KV 6,3A FC VB 292/65	6/12	292	65	6,3	67420-0060	1	HH 2	0,026	0,014	111,90
HH-SI 6/12KV 16A FC VB 292/65	6/12	292	65	16	67420-0160	1	HH 2	0,048	0,014	111,90
HH-SI 6/12KV 25A FC VB 292/65	6/12	292	65	25	67420-0250	1	HH 2	0,069	0,014	111,90
HH-SI 6/12KV 40A FC VB 292/78	6/12	292	78	40	67420-0400	1	HH 2	0,121	0,017	136,00
HH-SI 6/12KV 50A FC VB 292/88	6/12	292	88	50	67420-0500	1	HH 2	0,140	0,020	149,00
HH-SI 10/24KV 4A FC VB 442/78	10/24	442	78	4,0	67440-0040	1	HH 1			on demand
HH-SI 10/24KV 6,3A FC VB 442/78	10/24	442	78	6,3	67440-0060	1	HH 2	0,036	0,017	123,00
HH-SI 10/24KV 10A FC VB 442/78	10/24	442	78	10	67440-0100	1	HH 2	0,073	0,017	123,00
HH-SI 10/24KV 16A FC VB 442/78	10/24	442	78	16	67440-0160	1	HH 2	0,083	0,017	146,00
HH-SI 10/24KV 25A FC VB 442/88	10/24	442	88	25	67440-0250	1	HH 2	0,128	0,017	161,00



67220-0400

HV back-up Fuse-Links according to VDE 0670 T4 / IEC 60 282-1

Description	Rated voltage kV	Length	Ø	Amps	Order-No.	PU	PG	Sur. Ag	Sur. Cu	Price €/pc.
HH-SI 3/7,2KV 2A FC TB 192/56	3/7,2	192	56	2	67210-0020	1	HH 1	0,019	0,012	65,70
HH-SI 3/7,2KV 4A FC TB 192/56	3/7,2	192	56	4	67210-0040	1	HH 1	0,019	0,012	67,70
HH-SI 3/7,2KV 63A FC TB 192/65	3/7,2	192	65	63	67210-0630	1	HH 1	0,046	0,014	68,00
HH-SI 3/7,2KV 80A FC TB 192/65	3/7,2	192	65	80	67210-0800	1	HH 1	0,056	0,014	68,50
HH-SI 3/7,2KV 100A FC TB 192/65	3/7,2	192	65	100	67210-1000	1	HH 1	0,014	0,067	75,00
HH-SI 3/7,2KV 160A FC TB 192/88	3/7,2	192	88	160	67210-1600	1	HH 1	0,140	0,020	78,50
HH-SI 3/7,2KV 200A FC TB 192/88	3/7,2	192	88	200	67210-2000	1	HH 1	0,161	0,020	136,00
HH-SI 6/12KV 1A FC TB 292/56	6/12	292	56	1	67220-0010	1	HH 1	0,015	0,012	71,00
HH-SI 6/12KV 2A FC TB 292/56	6/12	292	56	2	67220-0020	1	HH 1	0,017	0,012	71,00
HH-SI 6/12KV 4A FC TB 292/56	6/12	292	56	4	67220-0040	1	HH 1	0,017	0,012	71,00
HH-SI 6/12KV 6,3A FC TB 292/56	6/12	292	56	6.3	67220-0060	1	HH 1	0,022	0,012	68,95
HH-SI 6/12KV 10A FC TB 292/56	6/12	292	56	10	67220-0100	1	HH 1	0,024	0,012	59,95
HH-SI 6/12KV 16A FC TB 292/56	6/12	292	56	16	67220-0160	1	HH 1	0,021	0,012	68,95
HH-SI 6/12KV 20A FC TB 292/56	6/12	292	56	20	67220-0200	1	HH 1	0,027	0,012	68,95
HH-SI 6/12KV 25A FC TB 292/56	6/12	292	56	25	67220-0250	1	HH 1	0,031	0,012	70,00
HH-SI 6/12KV 31,5A FC TB 292/56	6/12	292	56	31.5	67220-0320	1	HH 1	0,032	0,012	70,00
HH-SI 6/12KV 40A FC TB 292/56	6/12	292	56	40	67220-0400	1	HH 1	0,047	0,012	93,70
HH-SI 6/12KV 50A FC TB 292/56	6/12	292	56	50	67220-0500	1	HH 1	0,058	0,012	93,70
HH-SI 6/12KV 63A FC TB 292/56	6/12	292	56	63	67220-0630	1	HH 1	0,074	0,012	93,70
HH-SI 6/12KV 80A FC TB 292/65	6/12	292	65	80	67220-0800	1	HH 1	0,081	0,014	103,50
HH-SI 6/12KV 100A FC TB 292/65	6/12	292	65	100	67220-1000	1	HH 1	0,098	0,014	103,50
HH-SI 6/12KV 125A FC TB 292/88	6/12	292	88	125	67220-1250	1	HH 1	0,165	0,020	112,20
HH-SI 6/12KV 160A FC TB 292/88	6/12	292	88	160	67220-1600	1	HH 1	0,213	0,020	134,00
HH-SI 6/12KV 200A FC TB 292/88	6/12	292	88	200	67220-2000	1	HH 1	0,247	0,020	142,50
HH-SI 10/17,5KV 2A FC TB 367/56	10/17,5	367	56	2	67230-0020	1	HH 1	0,025	0,012	74,40
HH-SI 10/17,5KV 4A FC TB 367/56	10/17,5	367	56	4	67230-0040	1	HH 1	0,025	0,012	74,30
HH-SI 10/17,5KV 50A FC TB 367/65	10/17,5	367	65	50	67230-0500	1	HH 1	0,068	0,014	95,90
HH-SI 10/17,5KV 63A FC TB 367/65	10/17,5	367	65	63	67230-0630	1	HH 1	0,087	0,014	98,00
HH-SI 10/17,5KV 80A FC TB 367/65	10/17,5	367	65	80	67230-0800	1	HH 1	0,114	0,014	103,30
HH-SI 10/17,5KV 100A FC TB 367/65	10/17,5	367	65	100	67230-1000	1	HH 1	0,139	0,014	103,30
HH-SI 10/24KV 1A FC TB 442/56	10/24	442	56	1	67240-0010	1	HH 1	0,016	0,012	72,20
HH-SI 10/24KV 2A FC TB 442/56	10/24	442	56	2	67240-0020	1	HH 1	0,017	0,012	72,20
HH-SI 10/24KV 4A FC TB 442/56	10/24	442	56	4	67240-0040	1	HH 1	0,019	0,012	72,20
HH-SI 10/24KV 6,3A FC TB 442/56	10/24	442	56	6.3	67240-0060	1	HH 1	0,026	0,012	72,20
HH-SI 10/24KV 10A FC TB 442/56	10/24	442	56	10	67240-0100	1	HH 1	0,030	0,012	72,20
HH-SI 10/24KV 16A FC TB 442/56	10/24	442	56	16	67240-0160	1	HH 1	0,027	0,012	75,35
HH-SI 10/24KV 20A FC TB 442/56	10/24	442	56	20	67240-0200	1	HH 1	0,033	0,012	75,35
HH-SI 10/24KV 25A FC TB 442/56	10/24	442	56	25	67240-0250	1	HH 1	0,040	0,012	102,30

High Voltage Fuse-Links

For more information
see page 364

HV back-up Fuse-Links according to VDE 0670 T4 / IEC 60 282-1

Description	Rated voltage kV	Length	Ø	Amps	Order-No.	PU	PG	Sur. Ag	Sur. Cu	Price €/pc.
HH-SI 10/24KV 31,5A FC TB 442/56	10/24	442	56	31.5	67240-0320	1	HH 1	0,046	0,012	105,50
HH-SI 10/24KV 40A FC TB 442/56	10/24	442	56	40	67240-0400	1	HH 1	0,080	0,012	105,50
HH-SI 10/24KV 50A FC TB 442/56	10/24	442	56	50	67240-0500	1	HH 1	0,102	0,012	105,50
HH-SI 10/24KV 63A FC TB 442/65	10/24	442	65	63	67240-0630	1	HH 1	0,140	0,012	111,90
HH-SI 10/24KV 80A FC TB 442/65	10/24	442	65	80	67240-0800	1	HH 1	0,146	0,014	115,20
HH-SI 10/24KV 100A FC TB 442/78	10/24	442	78	100	67240-1000	1	HH 1	0,149	0,017	117,40
HH-SI 10/24KV 125A FC TB 442/88	10/24	442	88	125	67240-1250	1	HH 1	0,175	0,017	157,20
HH-SI 10/24KV 160A FC TB 442/88	10/24	442	88	160	67240-1600	1	HH 1	0,237	0,020	179,00
HH-SI 10/24KV 200A FC TB 442/88	10/24	442	88	200	67240-2000	1	HH 1	0,462	0,020	239,00
HH-SI 20/36KV 2A FC TB 537/56	20/36	537	56	2	67250-0020	1	HH 1	0,030	0,012	90,40
HH-SI 20/36KV 4A FC TB 537/56	20/36	537	56	4	67250-0040	1	HH 1	0,030	0,012	90,40
HH-SI 20/36KV 6,3A FC TA 537/56	20/36	537	56	6,3	67150-0060	1	HH 1	0,030	0,012	90,45
HH-SI 20/36KV 10A FC TA 537/56	20/36	537	56	10	67150-0100	1	HH 1	0,052	0,012	90,45
HH-SI 20/36KV 16A FC TA 537/56	20/36	537	56	16	67150-0160	1	HH 1	0,044	0,012	90,45
HH-SI 20/36KV 20A FC TA 537/56	20/36	537	56	20	67150-0200	1	HH 1	0,054	0,012	90,45
HH-SI 20/36KV 25A FC TA 537/56	20/36	537	56	25	67150-0250	1	HH 1	0,064	0,012	137,30
HH-SI 20/36KV 31,5A FC TA 537/65	20/36	537	65	31,5	67150-0320	1	HH 1	0,086	0,014	141,50
HH-SI 20/36KV 40A FC TA 537/65	20/36	537	65	40	67150-0400	1	HH 1	0,106	0,014	152,00
HH-SI 20/36KV 50A FC TA 537/88	20/36	537	88	50	67150-0500	1	HH 1	0,156	0,020	155,00
HH-SI 20/36KV 63A FC TA 537/88	20/36	537	88	63	67150-0630	1	HH 1	0,183	0,020	160,00



67520-0100

HV back-up Fuse-Links according to VDE 0670 T4 / IEC 60 282-1 with controlled power dissipation (ÜLA)

Description	Rated voltage kV	Length	Ø	Amps	Order-No.	PU	PG	Sur. Ag	Sur. Cu	Price €/pc.
HH-SI 6/12KV 1A FC TB ÜLA 292/56	6/12	292	56	1	67220-0019	1	HH 1	0,015	0,012	75,40
HH-SI 6/12KV 2A FC TB ÜLA 292/56	6/12	292	56	2	67220-0029	1	HH 1	0,016	0,012	75,40
HH-SI 6/12KV 4A FC TB ÜLA 292/56	6/12	292	56	4	67220-0049	1	HH 1	0,017	0,012	75,40
HH-SI 6/12KV 6,3A FC TB ÜLA 292/56	6/12	292	56	6.3	67220-0069	1	HH 1	0,022	0,012	73,20
HH-SI 6/12KV 10A FC TB ÜLA 292/56	6/12	292	56	10	67220-0109	1	HH 1	0,024	0,012	73,20
HH-SI 6/12KV 16A FC TB ÜLA 292/56	6/12	292	56	16	67220-0169	1	HH 1	0,021	0,012	73,20
HH-SI 6/12KV 20A FC TB ÜLA 292/56	6/12	292	56	20	67220-0209	1	HH 1	0,027	0,012	73,20
HH-SI 6/12KV 25A FC TB ÜLA 292/56	6/12	292	56	25	67220-0259	1	HH 1	0,031	0,012	74,30
HH-SI 6/12KV 31,5A FC TB ÜLA 292/56	6/12	292	56	31.5	67220-0329	1	HH 1	0,032	0,012	74,30
HH-SI 6/12KV 40A FC TB ÜLA 292/56	6/12	292	56	40	67220-0409	1	HH 1	0,047	0,012	99,00
HH-SI 6/12KV 50A FC TB ÜLA 292/56	6/12	292	56	50	67220-0509	1	HH 1	0,058	0,012	99,00
HH-SI 6/12KV 63A FC TB ÜLA 292/56	6/12	292	56	63	67220-0639	1	HH 1	0,074	0,012	99,00
HH-SI 6/12KV 80A FC TB ÜLA 292/65	6/12	292	65	80	67220-0809	1	HH 1	0,081	0,014	106,70
HH-SI 6/12KV 100A FC TB ÜLA 292/65	6/12	292	65	100	67220-1009	1	HH 1	0,098	0,014	106,70
HH-SI 6/12KV 125A FC TB ÜLA 292/88	6/12	292	88	125	67220-1259	1	HH 1	0,165	0,020	118,50
HH-SI 6/12KV 160A FC TB ÜLA 292/88	6/12	292	88	160	67220-1609	1	HH 1	0,219	0,020	140,00
HH-SI 6/12KV 200A FC TB ÜLA 292/88	6/12	292	88	200	67220-2009	1	HH 1	0,252	0,020	145,00
HH-SI 10/24KV 1A FC TB ÜLA 442/56	10/24	442	56	1	67240-0019	1	HH 1	0,016	0,012	76,45
HH-SI 10/24KV 2A FC TB ÜLA 442/56	10/24	442	56	2	67240-0029	1	HH 1	0,017	0,012	76,45
HH-SI 10/24KV 4A FC TB ÜLA 442/56	10/24	442	56	4	67240-0049	1	HH 1	0,019	0,012	76,45
HH-SI 10/24KV 6,3A FC TB ÜLA 442/56	10/24	442	56	6.3	67240-0069	1	HH 1	0,026	0,012	76,45
HH-SI 10/24KV 10A FC TB ÜLA 442/56	10/24	442	56	10	67240-0109	1	HH 1	0,030	0,012	76,45
HH-SI 10/24KV 16A FC TB ÜLA 442/56	10/24	442	56	16	67240-0169	1	HH 1	0,027	0,012	81,85
HH-SI 10/24KV 20A FC TB ÜLA 442/56	10/24	442	56	20	67240-0209	1	HH 1	0,033	0,012	81,85
HH-SI 10/24KV 25A FC TB ÜLA 442/56	10/24	442	56	25	67240-0259	1	HH 1	0,040	0,012	105,50
HH-SI 10/24KV 31,5A FC TB ÜLA 442/56	10/24	442	56	31.5	67240-0329	1	HH 1	0,046	0,012	110,90
HH-SI 10/24KV 40A FC TB ÜLA 442/56	10/24	442	56	40	67240-0409	1	HH 1	0,080	0,012	110,90
HH-SI 10/24KV 50A FC TB ÜLA 442/56	10/24	442	56	50	67240-0509	1	HH 1	0,102	0,012	110,90
HH-SI 10/24KV 63A FC TB ÜLA 442/56	10/24	442	65	63	67240-0639	1	HH 1	0,140	0,012	116,30
HH-SI 10/24KV 80A FC TB ÜLA 442/65	10/24	442	65	80	67240-0809	1	HH 1	0,146	0,014	119,50
HH-SI 10/24KV 100A FC TB ÜLA 442/78	10/24	442	78	100	67240-1009	1	HH 1	0,149	0,017	120,50

HH

High Voltage Fuse-Links

For more information
see page **364**



67004-0100

HV back-up Fuse-Links 6/12 kV with dimension "e" 442 mm (24 kV-body)

Description	Rated voltage kV	Length	Ø	Amps	Order-No.	PU	PG	Sur. Ag	Sur. Cu	Price €/pc.
HH-SI 6/12KV 1A FC TB 442/56	6/12	442	56	1	67004-0010	1	HH1	0,015	0,012	79,65
HH-SI 6/12KV 2A FC TB 442/56	6/12	442	56	2	67004-0020	1	HH1	0,016	0,012	79,65
HH-SI 6/12KV 4A FC TB 442/56	6/12	442	56	4	67004-0040	1	HH1	0,017	0,012	81,50
HH-SI 6/12KV 6,3A FC TB 442/56	6/12	442	56	6.3	67004-0060	1	HH1	0,022	0,012	81,50
HH-SI 6/12KV 10A FC TB 442/56	6/12	442	56	10	67004-0100	1	HH1	0,024	0,012	83,50
HH-SI 6/12KV 16A FC TB 442/56	6/12	442	56	16	67004-0160	1	HH1	0,021	0,012	83,50
HH-SI 6/12KV 20A FC TB 442/56	6/12	442	56	20	67004-0200	1	HH1	0,027	0,012	95,00
HH-SI 6/12KV 25A FC TB 442/56	6/12	442	56	25	67004-0250	1	HH1	0,031	0,012	95,00
HH-SI 6/12KV 31,5A FC TB 442/56	6/12	442	56	31.5	67004-0320	1	HH1	0,032	0,012	97,50
HH-SI 6/12KV 40A FC TB 442/56	6/12	442	56	40	67004-0400	1	HH1	0,047	0,012	97,50
HH-SI 6/12KV 50A FC TB 442/56	6/12	442	56	50	67004-0500	1	HH1	0,058	0,012	98,00
HH-SI 6/12KV 63A FC TB 442/56	6/12	442	56	63	67004-0630	1	HH1	0,074	0,014	98,00
HH-SI 6/12KV 80A FC TB 442/65	6/12	442	65	80	67004-0800	1	HH1	0,081	0,014	98,00
HH-SI 6/12KV 100A FC TB 442/65	6/12	442	65	100	67004-1000	1	HH1	0,098	0,020	143,00
HH-SI 6/12KV 125A FC TB 442/88	6/12	442	88	125	67004-1250	1	HH1	0,165	0,020	168,00
HH-SI 6/12KV 160A FC TB 442/88	6/12	442	88	160	67004-1600	1	HH1	0,219	0,020	188,00
HH-SI 6/12KV 200A FC TB 442/88	6/12	442	88	200	67004-2000	1	HH1	0,457	0,020	210,00



67004-0019

HV back-up Fuse-Links 6/12 kV with dimension "e" 442 mm (24 kV-body) with controlled power dissipation (ÜLA)

Description	Rated voltage kV	Length	Ø	Amps	Order-No.	PU	PG	Sur. Ag	Sur. Cu	Price €/pc.
HH-SI 6/12KV 1A FC TB 442/56 ÜLA	6/12	442	56	1	67004-0019	1	HH1	0,016	0,012	79,65
HH-SI 6/12KV 2A FC TB 442/56 ÜLA	6/12	442	56	2	67004-0029	1	HH1	0,017	0,012	79,65
HH-SI 6/12KV 4A FC TB 442/56 ÜLA	6/12	442	56	4	67004-0049	1	HH1	0,019	0,012	81,50
HH-SI 6/12KV 6,3A FC TB 442/56 ÜLA	6/12	442	56	6.3	67004-0069	1	HH1	0,026	0,012	81,50
HH-SI 6/12KV 10A FC TB 442/56 ÜLA	6/12	442	56	10	67004-0109	1	HH1	0,030	0,012	83,50
HH-SI 6/12KV 16A FC TB 442/56 ÜLA	6/12	442	56	16	67004-0169	1	HH1	0,027	0,012	95,00
HH-SI 6/12KV 20A FC TB 442/56 ÜLA	6/12	442	56	20	67004-0209	1	HH1	0,033	0,012	95,00
HH-SI 6/12KV 25A FC TB 442/56 ÜLA	6/12	442	56	25	67004-0259	1	HH1	0,040	0,012	95,00
HH-SI 6/12KV 31,5A FC TB 442/56 ÜLA	6/12	442	56	31.5	67004-0329	1	HH1	0,046	0,012	97,50
HH-SI 6/12KV 40A FC TB 442/56 ÜLA	6/12	442	56	40	67004-0409	1	HH1	0,080	0,012	97,50
HH-SI 6/12KV 50A FC TB 442/56 ÜLA	6/12	442	56	50	67004-0509	1	HH1	0,102	0,012	98,00
HH-SI 6/12KV 63A FC TB 442/56 ÜLA	6/12	442	56	63	67004-0639	1	HH1	0,140	0,012	98,00
HH-SI 6/12KV 80A FC TB 442/65 ÜLA	6/12	442	65	80	67004-0809	1	HH1	0,146	0,014	98,00
HH-SI 6/12KV 100A FC TB 442/65 ÜLA	6/12	442	65	100	67004-1009	1	HH1	0,149	0,017	143,00
HH-SI 6/12KV 125A FC TB 442/88 ÜLA	6/12	442	88	125	67004-1259	1	HH1	0,165	0,020	168,00
HH-SI 6/12KV 160A FC TB 442/88 ÜLA	6/12	442	88	160	67004-1609	1	HH1	0,219	0,020	188,00
HH-SI 6/12KV 200A FC TB 442/88 ÜLA	6/12	442	88	200	67004-2009	1	HH1	0,457	0,020	210,00

High Voltage Fuse-Links

For more information
see page **364**



High-voltage Fuse-Links for Voltage Transformers (HSW) acc. To VDE 0670 T4/IEC 60 282-1

67036-0003

Description	Rated voltage kV	Length	Ø	Amps	Order-No.	PU	PG	Sur. Ag	Sur. Cu	Price €/pc.
with indicator	6/12	160	22	1,6	67036-0004	1	HH	1		78,60
with indicator	15/24	280	22	1,4	67037-0004	1	HH	1		94,85
without indicator	6/12	160	22	1,25	67036-0003	1	HH	1		62,45
without indicator	15/24	280	22	1,25	67037-0003	1	HH	1		78,60
without indicator	20/36	421	37	1	67088-0003	1	HH	1		90,15

Accessories for High Voltage Fuse-Links

For more information
see page **364**

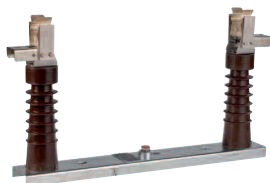

68007-0010

HV Fuse-Bases acc. to DIN 43 624 for indoor

Description	Rated voltage kV	Length	Ø	Order-No.	PU	PG	Sur. Ag	Sur. Cu	Price €/pc.
HV Fuse-Bases	12	293	45	68007-0010	1	netto			61,40
HV Fuse-Bases	24	443	45	68008-0010	1	netto			74,30
HV Fuse-Bases	36	538	45	68012-0010	1	netto			128,00



67033-0003

High Voltage Solid-Links

Description	Rated voltage kV	Length	Ø	Order-No.	PU	PG	Sur. Ag	Sur. Cu	Price €/pc.
HV Solid-Link 292/51	12	292	51	67033-0003	1	HH 1			79,65
HV Solid-Link 442/51	24	442	51	67034-0003	1	HH 1			101,00

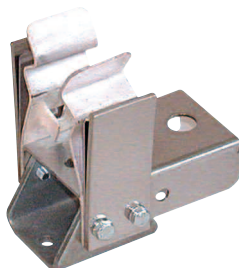

68016-0010

Fuse-base contacts, rated current 200 A

Description	Rated voltage kV	Length	Ø	Amps	Order-No.	PU	PG	Sur. Ag	Sur. Cu	Price €/pc.
Fuse-Base contacts				200	68016-0010	1	HH 2			23,90
Fuse-Base contacts				200	81931-0100	1	HH 2			23,70



68003-0100

Adapter for HV Fuses according to DIN 43 625

Properties:

- For extension of Fuse-Links from dimension e 292 mm (12 kV) to 442 mm (24 kV).

Description	Rated voltage kV	Length	Ø	Amps	Order-No.	PU	PG	Sur. Ag	Sur. Cu	Price €/pc.
Adapter		45	200	200	68003-0100	1	HH 2	0,022		107,00

Accessories for High Voltage Fuse-Links

For more information
see page **364**



Holder

Properties:

- Holder for 3 HV Fuse-Links

68004-0010

Description	Rated voltage kV	Length	Ø	Amps	Order-No.	PU	PG	Sur. Ag	Sur. Cu	Price €/pc.
Holder					68004-0010	1	HH 3			75,50



Test device for tripping device.

Description	Rated voltage kV	Length	Ø	Amps	Order-No.	PU	PG	Sur. Ag	Sur. Cu	Price €/pc.
Test device 192 mm, 65 Nm	7,2				68013-0020	1	netto			655,00
Extension to 292 mm		12			68014-0010	1	netto			38,80
Extension to 442 mm		24			68015-0010	1	netto			54,90

68013-0020

General information

HV Fuse-Links have been used for reliable protection in medium-voltage switchgear and controlgear and systems for decades. They protect apparatus and equipment against the thermal and dynamic effects of short-circuits.

The outstanding features of EFEN HV Fuse-Links are:

- High breaking capacity
- High current limitation
- Low switching voltage
- Quick breaking
- Non-ageing

EFEN HV Fuse-Links conform to the following standards:

- VDE 0670 T4/IEC 60 282-1: High-voltage fuses "current-limiting fuses"
- VDE 0670 T402: Selection of current-limiting fuses for transformer circuits
- IEC 60 787: Application guide for the selection of Fuse-Links of high-voltage fuses for transformer circuit applications
- VDE 0671 T105/IEC 62271-105: High-voltage alternating current switch-fuse combinations
- DIN 43 625: High-voltage fuses, rated voltages 3,6 to 36 kV (Fuse-Link dimensions)
- DIN 43 624: High-voltage fuses, rated voltages 3/3,6 to 30/36 kV (single-pole fuse bases)

Striker

The striker of HV Fuse-Links in this product list has an effective length of 30 mm and is a "medium" type. This classification results from the energy released by the striker between the points A and B (within the first 20 mm of the operating distance). The initial force is about 80 N, the force at the end of free movement is about 15 N.

The striker serves for actuation of the trip-free mechanism of the switch.

Terms and definitions

According to the applicable standards and physical properties, distinction is made between back-up and general purpose Fuse-Links:

Back-up Fuse-Links

Back-up Fuse-Links have a "rated minimum breaking current" (I_3) from which the Fuse-Links are able to interrupt current. Back-up Fuse-Links are not supposed to operate below their "minimum breaking current" (below I_3). Their operating range is from I_3 to the "rated maximum breaking current" (I_1).

For the assignment of back-up Fuse-Links, it is important to note that the lowest short circuit current is higher at the site of the HV back-up Fuse-Link than I_3 ($I_{Kmin} > I_3$). If the short-circuit current is lower than the minimum breaking current, additional protection must be provided.

General purpose Fuse-Links

EFEN general purpose Fuse-Links have an extended operating range for low currents. These Fuse-Links are capable of interrupting all currents from a current that causes the Fuse-Link to melt within a time not less than 1 hour up to the "maximum rated breaking current" (I_1). These Fuse-Links are therefore also able to reliably interrupt low fault currents.

The quality management system of EFEN GmbH is certified to the international standard DIN ISO 9001 (EN 29001).

EFEN operates a certified environment management system conforming to DIN ISO 14001 and the Eco Audit Order of the Council (EEC) 1836/93.

EFEN manufactures HV Fuse-Links with dimensions conforming to DIN 43 625 with striker for indoor and outdoor use, where the striker serves for actuating a trip-free mechanism as well as an indicator due to its red colour.

In addition to the HV Fuse-Links shown in this brochure, EFEN also manufactures a wide range of special Fuse-Links in other or special dimensions. If you have a particular application that requires

special fuse protection problems, simply ask the EFEN team, we are there for you!

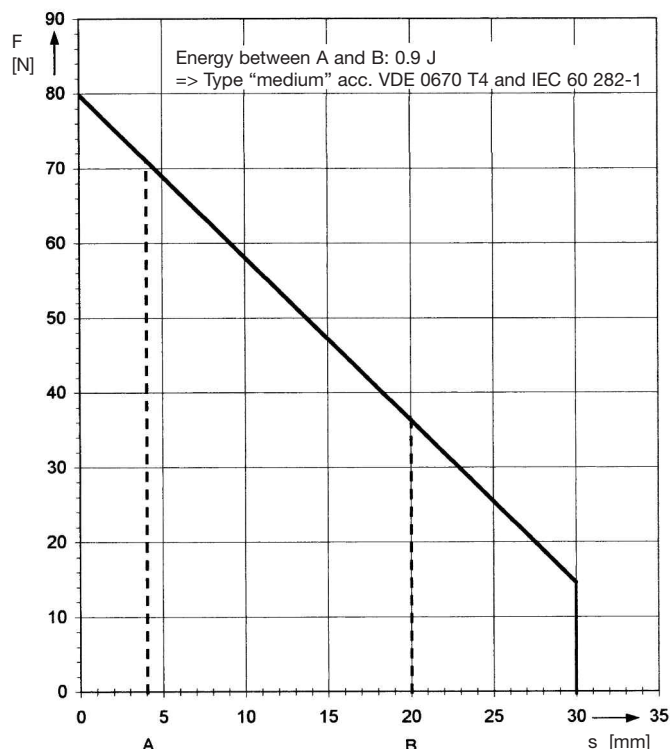

Fig.1

Rated voltage range

It is important for HV Fuse-Links that they must be operated at the voltage for which it has been rated. Accordingly, the operating voltage corresponds to the maximum rated voltage of the Fuse-Link. Owing to the switching voltage occurring during arcing, the Fuse-Link cannot be used at lower voltages without limitation. A lower operating voltage at which the Fuse-Link can still be used without exceeding the system insulation level during extinction must therefore be taken into account.

From these two values results the permissible voltage range of the Fuse-Link, which is shown on the Fuse-Links or in the technical data, e.g. 10/24 kV.

Breaking capacity I_1

The breaking capacity is also referred to as the "rated maximum breaking current". This clearly indicates that this is the maximum current which can be interrupted by the Fuse-Link.

I_1 of the Fuse-Link must be greater than the maximum short-circuit current at the site of the Fuse-Link ($I_1 > I_{Kmax}$).

Minimum breaking current I_3

The minimum breaking current is referred to as the "rated minimum breaking current". This value must be specified for back-up Fuse-Links. From this current, back-up Fuse-Links are capable to breaking fault currents. The Fuse-Links must be assigned to the system so that no fault current below I_3 can occur at the site of the Fuse-Link (due to the system parameters or other protective devices).

Power dissipation of a Fuse-Link P_{warm}

The power dissipation of a HV Fuse-Link is specified at the rated current of the Fuse-Link. For protection with HV Fuse-Links, it should be noted that the operating current is normally half the rated current. Because of the physical relationships, the actual power dissipation is less than a quarter of the value P_{warm} for HV Fuse-Links shown in the technical data table.

Time-current characteristic (I/t characteristic)

The time-current characteristic shows the correlation between current and time up to the melting of a fuse-element. The virtual time (t_{vs}) is specified to enable a comparison of the I/t characteristics of Fuse-Links below 100 ms. For co-ordination with other protective devices, e.g. switches or circuit breakers, the melting energy I^2t must be referred to for melting times below 100 ms

Current limitation

At high short-circuit currents, HV Fuse-Links interrupt currents within several milliseconds. That means, the sinusoidal current does not reach its peak value and the HV Fuse-Links are current limiting devices. This is a significant advantage compared to mechanical switches whose contacts take longer to open and interrupt currents at natural zero. During this time, the peak short-circuit current is able to freely develop its dynamic force. By using HV Fuse-Links, this surge current is limited within several ms to a fraction of its peak value and the design of the subsequent system can be reduced in terms of dynamic forces.

Switching voltage

So that HV Fuse-Links perform a current-limiting action, the short-circuit current must be limited and reduced as it increases. This requires a switching voltage that exceeds the driving system voltage and forces the current to zero. This switching voltage must not exceed the specified permissible value of 2,2 times the peak value of the maximum rated voltage. EFEN HV Fuse-Links meet this requirement.

Dimensions

HV Fuse-Links in this product list conform to DIN 43 625. The contact cap dimensions defined in this standard are shown in Fig. 2. The dimension "e" varies depending on the rated voltage of HV Fuse-Links, which is shown as "dimension for fuses" in the technical data tables. The diameter "d" also varies with the rated current, whereby this dimension is also shown in the tables. (Tables on page 376, 379-380)

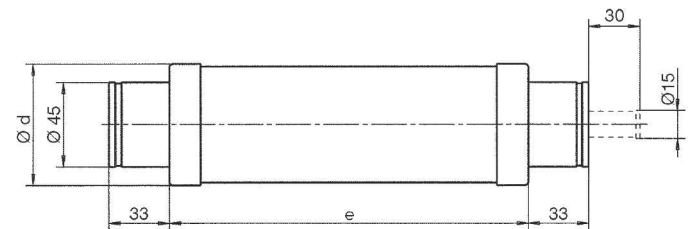

Fig. 2
Dimensions acc. to DIN 43 625 in mm

Description of further applications of EFEN HV Fuse-Links**Protection of high-voltage motors**

With EFEN HV back-up Fuse-Links, high-voltage squirrel-cage motors can be protected against the consequences of high short-circuit currents. An overload must be disconnected by accompanying protective device.

Protection of high-voltage capacitors

It is possible to protect individual capacitors using EFEN HV back-up Fuse-Links in the event of a short-circuit. However, particular aspects must be taken into account with respect to the rated voltage and rated current of the HV Fuse-Links.

Protection against distance short-circuits

HV Fuse-Links are not always used on busbars or directly at the feeder, but directly upstream of the transformer at the end of a spur line. In these cases, it should be noted that the shortcircuit current at the site of the HV Fuse-Links can be considerably lower than the current on a transformer secondary terminal short-circuit. In addition to the transformer impedance, the line impedance must also be taken into account.

Special applications

In addition to the standard applications described above, there are also a wide range of special applications for EFEN HV Fuse-Links:

- Protection of voltage transformers
- Protection of capacitive transformers
- Protection of railway installations (16 2/3 Hz or DC)

Oil-tight HV Fuse-Links

EFEN also manufactures HV Fuse-Links in an oil-tight design. These fuses can be directly integrated into the device to be protected, e.g. a transformer, and operated under oil. These HV Fuse-Links can be manufactured with and without striker. In addition, the contact caps can be provided with threaded bolts or nuts for cable lugs.

EFEN has developed a wide range of HV Fuse-Links for special applications, which would be too numerous to list here.

If you have a special protection task, we will be happy to assist you to find your optimum solution!

Protection of transformers

The following should be observed for HV Fuse-Link selection:

- a) Transformer ratings
 - Service voltage (U)
 - Rated output (S)
 - Relative short-circuit voltage (uk %)
 - Inrush current (8...12 IN)
- b) Time-current characteristic of HV Fuse-Links
- c) Secondary devices/selectivity

Procedure based on an example:

A 630 kVA transformer has a transformer rated current of 18,2 A at a service voltage of 20 kV. The relative short-circuit voltage is 4 % and the inrush current is 12 x IN. The short-circuit current on secondary terminal short-circuit is given from the relative short-circuit voltage. The transformer must be designed to withstand this current for 2 seconds. This condition results in point b) in Fig. 3. HV Fuse-Links must interrupt this current within 2 seconds. In Fig. 3, the Fuse-Link F4 must not be used for this transformer, as the Fuse-Link will require longer than 2 seconds to melt at this short-circuit current.

The inrush current is plotted for a duration of 0,1 seconds, resulting in point a). This inrush current must not melt the Fuse-Link, for which reason the Fuse-Link F1 cannot be used for this transformer. The Fuse-Links F2 and F3 may be used for this transformer, since their time-current characteristics are between the points a) and b). A transformer can thus be assigned several HV Fuse-Links for various rated currents. Decisive for selection of the correct fuse is the time-current characteristic and not the rated current of the HV Fuse-Link.

The German standard VDE 0670 T402, defines time-current ranges for rated currents, whereby the points a) and b) as well as the selectivity to the LV Fuse-Links of the utilization category gTr have also been taken into account. If an HV Fuse-Link is assigned to a transformer according to T402, all of the above factors must be taken into account for correct HV Fuse-Link selection.

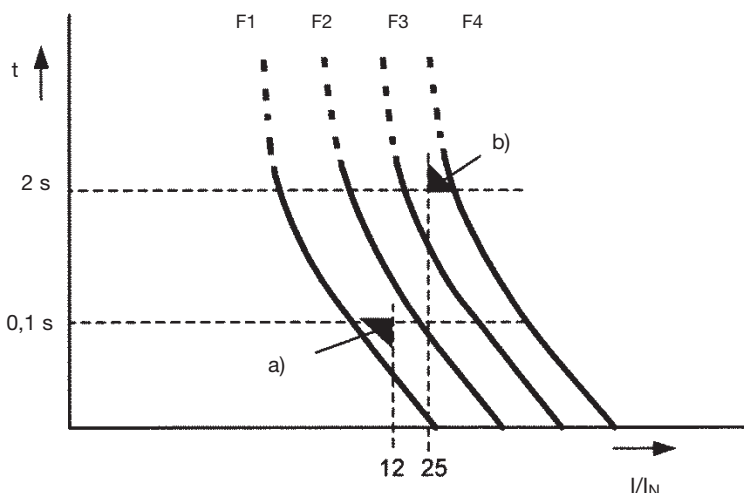

Fig. 3

F1- F4) Time-current characteristics of HV Fuse-Links

- a) Inrush current
- b) Lowest short-circuit current of transformer

HV back-up Fuse-Links acc. to VDE 0670/IEC 60 282-1 with controlled power dissipation ÜLA

Application

EFEN HV back-up fuses type ÜLA meet the requirements of VDE 0670 and were specifically developed to be installed in compact sized enclosed SF6 insulated substations. In these substations HV fuses are enclosed in narrow fuse compartments which on the one hand prevent efficient cooling of the fuses and on the other hand have a limited thermal power acceptance themselves (as a rule about 75 W). Overheating of fuse compartments in such enclosures is, however, not to be expected, if the fuses have been properly selected by their rated current according to the transformer to be protected (see table 3) and if the melting elements of the fuses are in faultless condition (Fig. 4).

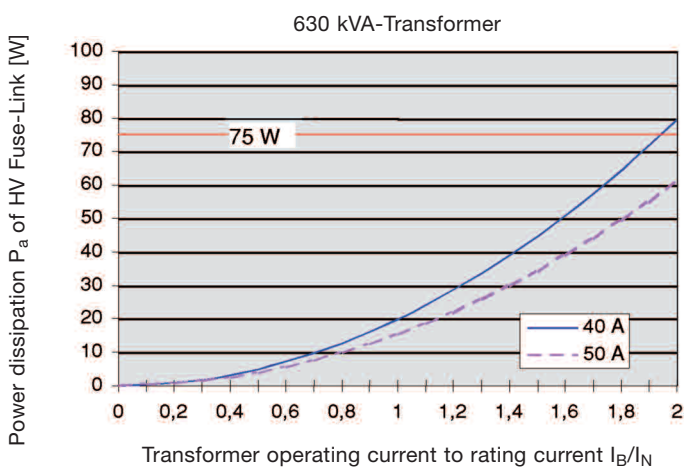

Fig. 4: Power dissipation of HV Fuse-Links 40 A and 50 A for a 20 kV, 630 kVA transformer

One or more of the melting elements connected in parallel may, however, be interrupted by transient currents caused by transformer inrush or lightning strikes. Fuses having one or more of the paralleled melting elements interrupted, dissipate significantly more heat than faultless fuses. There is a certain risk that the limited power acceptance of fuse compartments may be exceeded at or even below rated transformer current. EFEN HV back-up fuses type ÜLA prevent such potential overheating when installed in conjunction with a transformer switch having trip-free mechanism.

Function mode

As a rule, the power acceptance of fuse compartments in SF6 insulated switchgear is limited, to e.g. 75 W. In order to prevent thermal overheating, the power dissipation Pa of the fuse must not exceed this value:

$$P_a \leq 75 \text{ W}$$

The ÜLA striker system controls the power dissipation of the fuse according to Ohm's law (ÜLA means controlled power dissipation). The striker pin is released depending on the voltage drop across the fuse and, therefore depending on the power dissipation:

$$U_a = R \cdot I_B$$

$$U_a \cdot I_B = P_a \leq 75 \text{ W}$$

The release voltage Ua of the ÜLA striker system has been selected so that the fuse carrying the operating current IB does not exceed the limiting value, e.g. 75 W, when the resistance R of the fuse increases because of interrupted melting elements. In this case the ÜLA striker system controls the power dissipation of the fuse and releases the transformer switch before the permissible power acceptance of the fuse compartment will be exceeded (Fig. 5).

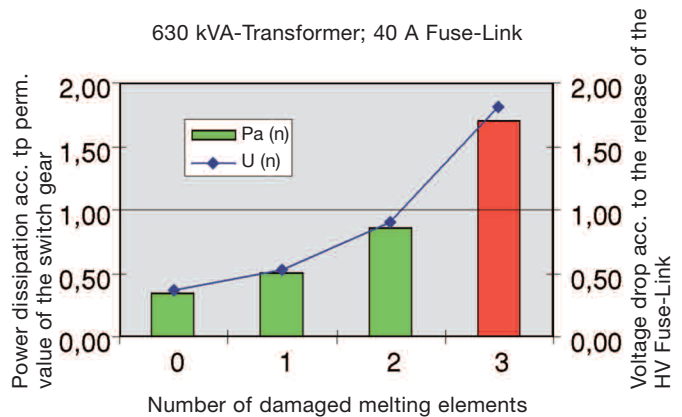

Fig. 5: Controlled power dissipation at 1.3 times transformer rated current

Benefits of thermal protection of the fuse compartment by ÜLA

- ÜLA controls the power dissipation of the Fuse-Links
- ÜLA is based on Ohm's law
- ÜLA works independent on the mounting position of the fuse
- ÜLA releases the striker, before an overheating is reached
- ÜLA mechanism is non-ageing

High-voltage alternating current switch-fuse combinations acc. to VDE 0671 T105/IEC 62 271-105

In order to increase the utilization range of a switch, it is combined with current limiting HV Fuse-Links. This combination unit offers short-circuit protection in addition to load switching capacity. HV Fuse-Links provide short-circuit protection, while the switch interrupts the currents below the take-over current of the combination unit. In addition to the inrush current, short-circuit current on secondary terminal short-circuits and low voltage selectivity, the following switch characteristics should be taken into account:

- rated transfer current ($I_{transfer}$)
- fuse-initiated opening time of the switch (t_0)

Fig. 6 shows the rated transfer current ($I_{transfer}$) as a vertical line. The fuse-initiated opening time (t_0) must be multiplied by 0,9 (procedure according to IEC 62 271-105) and a horizontal line be drawn. This results in an intersection that is characteristic to the switch and must be established for each switch individually.

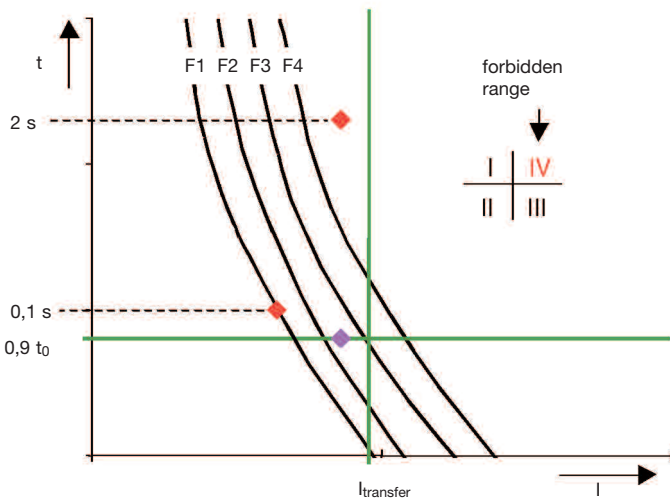

Fig. 6 Selection of HV Fuse-Links acc. to VDE 0671 T105/IEC 62 271.105

This switch intersection divides the sheet into four quadrants (see Fig. 6). Suitable for the switch-fuse combination are HV Fuse-Links only with a time-current characteristic that does not pass through quadrant IV ("forbidden area"). Generally suitable for use in switch-fuse combinations according to IEC 62 271-105 are all HV Fuse-Links with striker which meet this criterion.

EFEN has assigned HV Fuse-Links to the switch-fuse combination and the transformers of all major manufacturers. These documents are available on request.

EFEN General purpose Fuse-Links acc. VDE 0670 T4/IEC 60 282-1

EFEN HV general purpose Fuse-Links have an extended breaking range for low currents. By connecting two melting elements in series in one body, a special time-current characteristic results.

This enables selectivity between HV Fuse-Links and low voltage circuit-breakers.

Whilst one system can reliably interrupt low melting currents with long melting times (up to one hour), the other system interrupts high short-circuit currents. The time-current characteristic thus consists of two sections, where the takeover point (intersection) lies at about one second (see I/t characteristic F1 in Fig. 7).

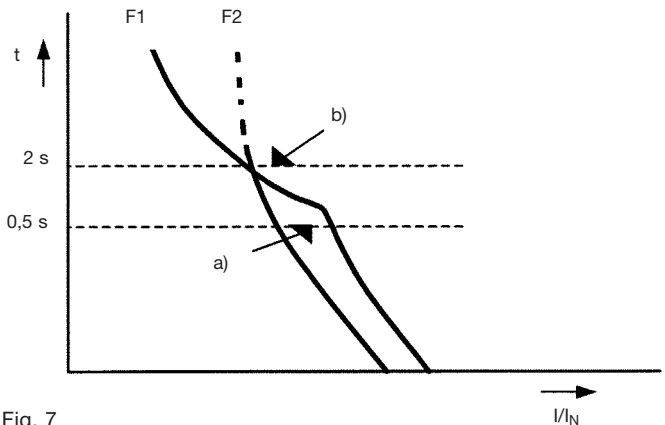

Fig. 7

- F1) Time-current characteristic of general purpose Fuse-Link
- F2) Time-current characteristic of back-up Fuse-Link
- a) Selectivity to low voltage circuit breaker
- b) lowest short-circuit current of transformer

In Fig. 7, point b) corresponds to the short-circuit current of a transformer. Point a) is the release current of a circuit breaker on the low voltage side, e.g. which is set to a release time of 0,5 seconds, transformed on the high-voltage side.

The transformer is protected by both Fuse-Links with the I/t characteristics F1 and F2, as the short-circuit current is interrupted within two seconds. If a selectivity of the HV Fuse-Link to the circuit-breaker (point a) is required, an EFEN HV general purpose Fuse-Link must be used on the high-voltage side. The time-current characteristic F1 is located to the right of point a) of the circuit-breaker in contrast to the I/t characteristic F2 of the HV back-up Fuse-Link, which would already melt prior to tripping of the circuit-breaker.

In a special manufacturing process, these HV general purpose Fuse-Links can also be produced in an oil-tight version and directly integrated into the transformer. These Fuse-Links without striker are provided with a threaded connection on both ends and can be operated under the oil of a transformer.

HV Fuse-Links for voltage transformer "HSW" acc. to VDE 0670 T4/IEC 60 282-1

HV Fuse-Links for voltage transformers (HSW) serve for short-circuit protection. They reliably disconnect the faulted transformer from the supply.

Their compact design enables integration into the transformer housing. By sealing the transformer housing with a screw cap, the HSW can be replaced and is visible from outside if the screw cap has a window. For status indication purposes, the HSW can be provided with an indicator. The HSW can be used for transformers with a limit rating up to 3000 VA (6 up to 12 kV) or 6000 VA (15 up to 24 kV).

The HSW operates highly current limiting on short-circuits, so that only a maximum peak current of 1 kA flows for several micro-seconds. In this way, reactions of the fault on the supplying system are largely suppressed.



Fig. 8

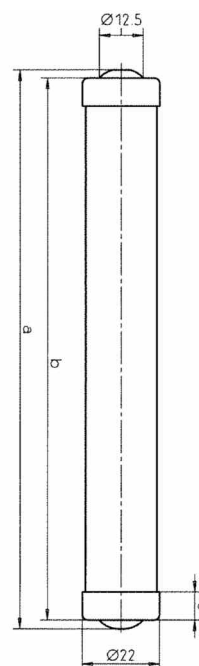

Fig. 9

HV Fuse-Links for voltage transformer
Electrical data, dimensions, weights

Order no.	Version	Rated voltage range U_N kV	Dimensions		Resistance	Weight	Pack
			a mm	b mm	R_{kalt} Ω	kg	
67036-0004	with indicator	6/12	160	155	7	0,15	1
67037-0004	with indicator	15/24	280	275	14	0,27	1
67036-0003	without indicator	6/12	160	155	7	0,15	1
67037-0003	without indicator	15/24	280	275	14	0,27	1
67088-0003	without indicator	20/36	421	-	9	2,7	1

Selection table for HV back-up Fuse-Links acc. to IEC 60 282-1 with selectivity to NH Fuse-Links (gTr/gG)
Table 1

Rated voltage range of Fuse-Link [kV]	Mode of protection Rated current of Fuse-Link [A]	Transformer output [kVA]											
		rel. short-circuit voltage $u_k = 4\%$										$u_k = 5\%$	
		50	100	125	160	200	250	315	400	500	630	800	1000
3/7,2	I_N Tr	4,8	9,6	12,0	15,4	19,2	24,1	30,3	38,5	48,1	60,6	77,1	96,3
	with NH gG	16	20-25	25-31,5	31,5-40	40-50	50-63	63-80	80-100	100-125	100-160	160	160
6	with NH gTr		20-25	25-31,5	31,5-40	40-50	50-63	63-80	80-100	100-125	100-160	160	160
	I_N Tr	2,9	5,8	7,2	9,2	11,5	14,4	18,2	23,1	28,9	36,4	46,2	57,7
10	with NH gG	10	16	16	20-25	25-31,5	31,5-40	40-50	50-63	63-80	80-100	100-125	100-125
	with NH gTr		16	16	20-25	25-31,5	31,5-40	40-50	50-63	63-80	80-100	100-125	100-160
10/24	I_N Tr	1,5	2,9	3,6	4,6	5,8	7,2	9,1	11,5	14,4	18,2	23,1	28,9
	with NH gG	6,3	10	10	16	16	16-25	25	25-31,5	31,5-40	40-50	63	63
20	with NH gTr		10	10	16	16	16-25	25	25-31,5	31,5-40	40-50	63	63-80
	I_N Tr	1,0	1,9	2,4	3,1	3,8	4,8	6,1	7,7	9,6	12,1	15,4	19,2
30	with NH gG		6,3	10	10	16	16-20	20-25	25	25-31,5	31,5-40	40-50	40-50
	with NH gTr		6,3	10	10	16	16-20	20-25	25	25-31,5	31,5-40	40-50	40-50
0,4	I_N Tr	72	144	180	231	289	361	455	577	722	909	1155	1443
	with NH gG	80	125/160	160/200	200/250	250/315	315/400	400/500	500/630	630/800	800/1000	1000/1250	1250/1600
	with NH gTr		100	125	160	200	250	315	400	500	630	800	1000

Bold typed figures are preferred values

 I_N Tr = Transformer rated current [A]

Selection table for HV back-up Fuse-Links acc. to IEC 60 282-1 with controlled power dissipation ŪLA with selectivity to NH gTr
Table 2

Rated voltage range of Fuse-Link [kV]	Mode of protection Rated current of Fuse-Link [A]	Transformer output [kVA]										
		rel. short-circuit voltage $u_k = 4\%$										$u_k = 5\%$
		100	125	160	200	250	315	400	500	630	800	1000
6/12	I_N Tr	5,8	7,2	9,2	11,5	14,4	18,2	23,1	28,9	36,4	46,2	57,7
	I_N	16	16	20	25	31,5	40	50	63	80	100	125
10	P_{warm}	2,4	3,6	4,5	5,3	6,3	8,6	10,7	10,4	13,1	28,5	18,3
	I_N Tr	2,9	3,6	4,6	5,8	7,2	9,1	11,6	14,4	18,2	23,1	28,9
20	I_N	10	10	16	16	16/25	25	25/31,5	31,5	40	63	63
	P_{warm}	3,3	5,0	2,9	4,6	7,2/3,8	6,2	10,2/8,3	13,0	15,2	14,0	22,7
20/36	I_N Tr	1,9	2,4	3,1	3,8	4,8	6,1	7,7	9,6	12,1	15,4	19,2
	I_N	6,3	10	10	16	16	20	25	25	31,5	40	40/50
30	P_{warm}	2,8	3,0	4,7	3,0	4,5	5,6	6,5	10,0	12,3	16,9	27,6/17,3

 I_N Tr = Transformer rated current [A]

 I_N = Rated current of Fuse-Link [A]

 P_{warm} = Power dissipation of HV Fuse-Links at rated current of transformer [W]

**Selection table for HV general purpose fuses
VDE 0670 T4/IEC 60282-1**
Table 3

Rated voltage range of Fuse-Link [kV]	Mode of protection Rated current of Fuse-Link [A]	Transformer output [kVA]											
		rel. short-circuit voltage $u_K = 4\%$										$u_K = 5\%$	
		50	100	125	160	200	250	315	400	500	630	800	1000
3/7,2	I_N Tr	4,8	9,6	12	15,4	19,2	24,1	30,3	38,5	48,1	60,6	77,1	96,3
6	I_N	6,3	16	16	16-25	25	25-40	40	40-50	50	50	-	-
6/12	I_N Tr	2,9	5,8	7,2	9,2	11,5	14,4	18,2	23,1	28,9	36,4	46,2	57,7
10	I_N	6,3	6,3-10	10	16	16	16-25	25	25-40	40	40-50	50	50
10/24	I_N Tr	1,5	2,9	3,6	4,6	5,8	7,2	9,1	11,5	14,4	18,2	23,1	28,9
20	I_N	-	4	4-6,3	6,3	6,3-10	10	16	16	16	25	25	25

I_N Tr = Transformer rated current [A]

I_N = Rated current of Fuse-Link [A]

Advantages of using EFEN HV general purpose Fuse-Links are:

- All currents, from the current that causes the melting to melt within a time of ≥ 1 hour up to the maximum rated breaking current I_1 being reliably interrupted
- Insensitive to lightning impulse current, low inrush sensitivity
- Very low power dissipation/low heating
- Selectivity to low voltage circuit-breaker possible
- EFEN HV general purpose Fuse-Links can be integrated into the transformer as an oil-tight variant

HV-Fuse links for protection of high voltage motor circuits

EFEN HV Fuse-Links are can be used for the protection of high voltage motors.

EFEN has the knowledge and the right product to protect your motor circuit.

Selection table acc. to T402

Table 4

High Voltage Motors	Number of starts per h	Maximum motor starting current (A)							
		Start Duration							
≤ 6 s	≤ 2	130	180	220	290	360	500	680	1100
	4	120	150	190	240	310	450	550	900
	10	110	140	170	220	270	400	490	770
	15	100	130	160	200	250	340	430	670
	30	90	120	140	190	230	320	400	630
6 – 15 s	2	120	160	190	240	310	430	580	670
	4	100	140	170	220	280	400	500	610
	10	90	120	150	200	240	340	430	540
	15	80	110	130	180	220	320	400	480
	30	70	100	120	160	200	290	350	430
15 – 60 s	2	100	130	160	220	270	380	470	590
	4	90	120	150	200	250	340	440	540
	6	80	110	140	190	230	320	400	500
	10	70	100	130	180	220	300	380	470

recommended Fuse-Link (acc. the norms IEC 60282-1 & VDE 0670 T4 & 402)

rated current:	63 A	80 A	100 A	125 A	160 A	2 x 100 A	2 x 125 A	2 x 160 A
----------------	------	------	-------	-------	-------	-----------	-----------	-----------

Order no.

Rated Motor Voltage	3 – 7,2 kV	67110-0630	67110-0800	67110-1000	67110-1250	67110-1600	67110-1000	67110-1250	67110-1600
	6 – 12 kV	67120-0630	67120-0800	67120-1000	67120-1250	67120-1600	67120-1000	67120-1250	67120-1600
	10 – 24 kV	67140-0630	67140-0800	67140-1000					
	20 – 36 kV	67150-0630							

Selection table acc. to T 4

Table 5

High Voltage Motors	Number of starts per h	Maximum motor starting current (A)							
		Start Duration							
≤ 6 s	≤ 2	120	165	210	320	370	430	900	1050
	4	110	140	180	275	320	380	730	870
	10	100	130	160	240	280	330	620	750
	15	90	120	150	220	260	300	560	650
	30	80	110	135	205	240	280	510	600
6 – 15 s	2	115	145	180	270	320	370	590	640
	4	95	125	160	240	280	340	530	570
	10	85	110	140	210	250	300	480	510
	15	75	100	120	190	230	280	430	450
	30	65	90	110	170	210	250	380	400
15 – 60 s	2	90	120	150	240	280	320	520	550
	4	80	110	140	220	260	290	470	510
	6	75	100	130	205	240	270	430	470
	10	65	90	120	195	230	250	400	440

recommended Fuse-Link (acc. the norms IEC 60282-1 & VDE 0670 T4 & 402)

rated current:	63 A	80 A	100 A	160 A	200 A	2 x 100 A	2 x 160 A	2 x 200 A
----------------	------	------	-------	-------	-------	-----------	-----------	-----------

Order no.

Rated Motor Voltage	3 – 7,2 kV	67210-0630	67210-0800	67210-1000	67210-1600	67210-2000	67210-1000	67210-1600	67210-2000
	6 – 12 kV		67220-0800	67220-1000	67220-1600	67220-2000	67220-1000	67220-1600	67220-2000
	10 –24 kV		67240-0800	67240-1000					

Selection table for protection of capacitors

Table 6

Rated voltage range of the Fuse-Link [kV]	3/7,2		6/12		10/24		20/36	
Service voltage of capacitors [kV]	3		6		10		20	
Service voltage of capacitors [kV]	Icr [A]	Ir [A] Fuse-Link	Icr [A]	Ir [A] Fuse-Link	Icr [A]	Ir [A] Fuse-Link	Icr [A]	Ir [A] Fuse-Link
		Order no.:		Order no.:		Order no.:		Order no.:
50	9,6	20 67110-0200	4,8	10 67220-0100	2,9	6,3 67240-060	1,44	4 67250-0040
100	19,2	40 67110-0400	9,6	20 67220-0200	5,8	10 67240-0100	2,9	6,3 67150-0060
125	24,1	50 67110-0500	12,0	25 67220-0250	7,2	16 67240-0160	3,6	6,3 67150-0060
160	30,8	80 67210-0800	15,4	31,5 67220-0320	9,2	20 67240-0200	4,6	10 67150-0100
200	38,5	100 67210-1000	19,2	50 67220-0500	11,5	25 67240-0250	5,8	16 67150-0160
250	48,1	125 67110-1250	24,1	63 67220-0630	14,4	31,5 67240-0320	7,2	16 67150-0160
315	60,6	160 67210-1600	30,3	80 67220-0800	18,2	50 67240-0500	9,1	20 67150-0200
400	77,0	200 67210-2000	38,5	100 67220-1000	23,1	63 67240-0630	11,5	25 67150-0250
500	96,2	2 x 125 2 x 67110-1250	48,1	125 67220-1250	28,9	80 67240-0800	14,4	31,5 67150-0320
630	121,2	2 x 160 2 x 67210-1600	60,6	160 67220-1600	36,4	100 67240-1000	18,2	40 67150-0400
800	154,0	2 x 200 2 x 67210-2000	77,0	200 67220-2000	46,2	125 67240-1250	23,1	50 67150-0500
1000	192,5	3 x 160 3 x 67210-1600	96,2	2 x 125 2 x 67220-2000	57,7	160 67240-1600	28,9	63 67150-0630

Selection table for protection of capacitors with HV Back-Up Fuse-Links Norm / Standard VDE 0670 T4 / IEC 60282-1

During the switching and regulating process of capacitors high currents like short-circuit occur. The high and duration of those currents are based on the marking angle, the frequency and inductivity of the grind and the size of the capacitors. For fusing of single capacitors, the next higher voltage level of the HV Fuse-Link should be selected. Also the rated current of HV back-up Fuse-Links should have a minimum of 2.5 times the capacitor rated current. The following table was made in conformance with IEC 549 High-Voltage Fuses for external protection of shunt power capacitors.

Definitions:

Icr = Capacitor rated current [A]
Ir = Rated current of Fuse-Link [A]

Protection table

HV back-up Fuse-Links acc. to VDE 0670/IEC 60 282-1 with controlled power dissipation

Table 7

rated voltage range of fuse link (kV)		6/12		10/24	
rated operating voltage of the transformer (kV)		10		20	
independence voltage	Transformer rated current (KVA)	Transformer rated current (A)	Rated current of Fuse-Link (A)	Transformer rated current (A)	Rated current of fuse link (A)
$u_K = 4\%$	50	2,9	10	1,5	4
	100	5,8	16 - 20	2,9	10
	125	7,2	20 - 25	3,6	10 - 16
	160	9,2	20 - 31,5	4,6	16 - 20
	200	11,5	25 - 40	5,8	16 - 20
	250	14,4	31,5 - 50	7,2	20 - 25
	315	18,2	40 - 63	9,1	20 - 31,5
	400	23,1	40 - 80	11,5	25 - 40
$u_K = 5\%$	500	28,9	50 - 100	14,4	31,5 - 50
	630	36,4	63 - 100	18,2	40 - 63
	800	46,2	80 - 125	23,1	40 - 63
$u_K = 6,25\%$	1000	57,7	100 - 160	28,9	50 - 80
	1250	72,2	125 - 200	36,1	63 - 100
	1600	92,4	125 - 200	46,2	80 - 100

bold printed currents are preferred values

Protection table

HV back-up Fuse-Links acc. to VDE 0670/IEC 60 282-1

Table 8

rated voltage range of fuse link (kV)		3/7,2		6/12		10/24		20/36	
rated operating voltage of the transformer (kV)		6		10		20		30	
independence voltage	Transformer rated current (KVA)	Transformer rated current (A)	Rated current of Fuse-Link (A)	Transformer rated current (A)	Rated current of Fuse-Link (A)	Transformer rated current (A)	Rated current of Fuse-Link (A)	Transformer rated current (A)	Rated current of Fuse-Link (A)
$u_K = 4\%$	50	4,8	16 - 20	2,9	10	1,5	4	0,96	2 - 6,3
	100	9,6	20 - 31,5	5,8	16 - 20	2,9	10	1,9	6,3 - 10
	125	12	25 - 40	7,2	20 - 25	3,6	10 - 16	2,4	10
	160	15,4	31,5 - 50	9,2	20 - 31,5	4,6	16 - 20	3,1	10
	200	19,2	40 - 63	11,5	25 - 40	5,8	16 - 20	3,8	10 - 16
	250	24,1	40 - 80	14,4	31,5 - 50	7,2	20 - 25	4,8	16 - 20
	315	30,3	50 - 100	18,2	40 - 63	9,1	20 - 31,5	6,1	16 - 25
	400	38,5	63 - 125	23,1	40 - 80	11,5	25 - 40	7,7	20 - 25
	500	48,1	80 - 160	28,9	50 - 100	14,4	31,5 - 50	9,6	20 - 31,5
	630	60,6	100 - 200	36,4	63 - 100	18,2	40 - 63	12,1	25 - 40
$u_K = 5\%$	800	77,1	125 - 200	46,2	80 - 125	23,1	40 - 63	15,4	31,5 - 40
	1000	96,3	125 - 160	57,7	100 - 160	28,9	50 - 80	19,2	40 - 50
	1250	120,3	160 - 200	72,2	125 - 200	36,1	63 - 100	24,1	40 - 50
$u_K = 6,25\%$	1600	154	200	92,4	125 - 200	46,2	80 - 100	30,8	50 - 63

bold printed currents are preferred values

HV back-up Fuse-Links acc. to VDE 0670 T402/IEC 60 282-1
 Electrical data, dimensions, weights

Table 9

Order no.	Rated voltage range	Rated current I_N A	Rated maximum breaking current I_1 kA	Rated minimum breaking current I_3 A	Dimensions		Resistances and power dissipation		Total I^2t A ² s	Weight kg	Pack
	U_N kV				e mm	d mm	R_{kalt} mΩ	P_{warm} W			
67110-0060	3/7,2	6,3	63	21	192	56	256	11	800	1,2	1
67110-0100	3/7,2	10	63	38	192	56	144	19	3.000	1,2	1
67110-0160	3/7,2	16	63	65	192	56	41	13	2.340	1,2	1
67110-0200	3/7,2	20	63	92	192	56	32	14,5	3.900	1,1	1
67110-0250	3/7,2	25	63	110	192	56	25	20	4.900	1,2	1
67110-0320	3/7,2	31,5	63	123	192	56	19	23	7.000	1,2	1
67110-0400	3/7,2	40	63	140	192	56	12,3	30	14.000	1,2	1
67110-0500	3/7,2	50	63	194	192	56	9,3	35	25.300	1,2	1
67110-0630	3/7,2	63	63	220	192	65	7,0	60	61.700	1,4	1
67110-0800	3/7,2	80	63	300	192	65	5,2	85	87.400	1,6	1
67110-1000	3/7,2	100	63	440	192	78	4,0	96	180.000	2,0	1
67110-1250	3/7,2	125	63	440	192	88	2,9	75	440.000	2,4	1
67110-1600	3/7,2	160	63	610	192	88	2,3	120	654.000	2,7	1
67120-0060	6/12	6,3	63	23	292	56	409	19	800	1,7	1
67120-0100	6/12	10	63	35	292	56	231	29	3.000	1,7	1
67120-0160	6/12	16	63	64	292	56	69	21	3.700	1,7	1
67120-0200	6/12	20	63	90	292	56	53	25	4.700	1,6	1
67120-0250	6/12	25	63	95	292	56	41	31	4.920	1,7	1
67120-0320	6/12	31,5	63	110	292	56	31	39	7.000	1,7	1
67120-0400	6/12	40	63	134	292	56	20	46	14.000	1,7	1
67120-0500	6/12	50	63	190	292	56	16,7	62	25.300	1,7	1
67120-0630	6/12	63	63	220	292	65	11,7	60	63.000	2,1	1
67120-0800	6/12	80	63	345	292	65	8,7	82	87.000	2,3	1
67120-1000	6/12	100	63	400	292	78	6,7	96	180.000	3,1	1
67120-1250	6/12	125	63	480	292	88	4,9	117	440.000	3,7	1
67120-1600	6/12	160	63	610	292	88	3,8	175	654.000	1,9	1
67130-0060	10/17,5	6,3	63	20	367	56	530	24	800	1,9	1
67130-0100	10/17,5	10	63	33	367	56	312	34	3.000	1,9	1
67130-0160	10/17,5	16	63	64	367	56	100	34	2.340	1,9	1
67130-0200	10/17,5	20	63	80	367	56	75	42	3.900	1,9	1
67130-0250	10/17,5	25	63	100	367	56	56	50	6.500	1,9	1
67130-0320	10/17,5	31,5	63	110	367	56	46	61	7.000	1,9	1
67130-0400	10/17,5	40	63	134	367	56	32	83	14.200	1,9	1
67130-0500	10/17,5	50	63	180	367	56	22	84	40.000	3,5	1
67130-0630	10/17,5	63	63	240	367	56	16	110	61.700	3,5	1
67130-0800	10/17,5	80	63	320	367	78	13	130	87.400	3,5	1
67130-1000	10/17,5	100	63	420	367	78	9,5	180	170.000	4,4	1
67140-0060	10/24	6,3	63	23	442	56	640	32	800	2,4	1
67140-0100	10/24	10	63	36	442	56	386	48	2.000	2,4	1
67140-0160	10/24	16	63	73	442	56	127	43	2.340	2,4	1
67140-0200	10/24	20	63	91	442	56	97	53	3.900	2,3	1
67140-0250	10/24	25	63	116	442	56	74	64	6.500	2,4	1
67140-0320	10/24	31,5	63	125	442	56	61	85	7.000	2,4	1
67140-0400	10/24	40	63	161	442	56	43	103	14.200	2,3	1
67140-0500	10/24	50	63	230	442	56	35	146	24.200	4,5	1
67140-0630	10/24	63	63	350	442	65	25	163	46.400	3,1	1
67140-0800	10/24	80	63	460	442	65	19	196	104.000	4,5	1
67140-1000	10/24	100	63	420	442	78	14	279	140.000	4,1	1
67150-0060	20/36	6,3	31,5	23	537	56	827	39	600	2,8	1
67150-0100	20/36	10	31,5	34	537	56	463	65	2.000	2,8	1
67150-0160	20/36	16	31,5	70	537	56	210	67	2.340	2,7	1
67150-0200	20/36	20	31,5	100	537	56	165	84	3.900	2,8	1
67150-0250	20/36	25	31,5	110	537	56	125	100	6.500	2,8	1
67150-0320	20/36	31,5	31,5	135	537	56	85	119	7.000	3,7	1
67150-0400	20/36	40	20	205	537	56	65	176	14.200	3,8	1
67150-0500	20/36	50	20	220	537	56	42	183	40.000	6,5	1
67150-0630	20/36	63	20	360	537	65	35	271	61.700	6,8	1

HV back-up Fuse-Links acc. to VDE 0670 T402 and T402 ÜLA

Time current characteristics

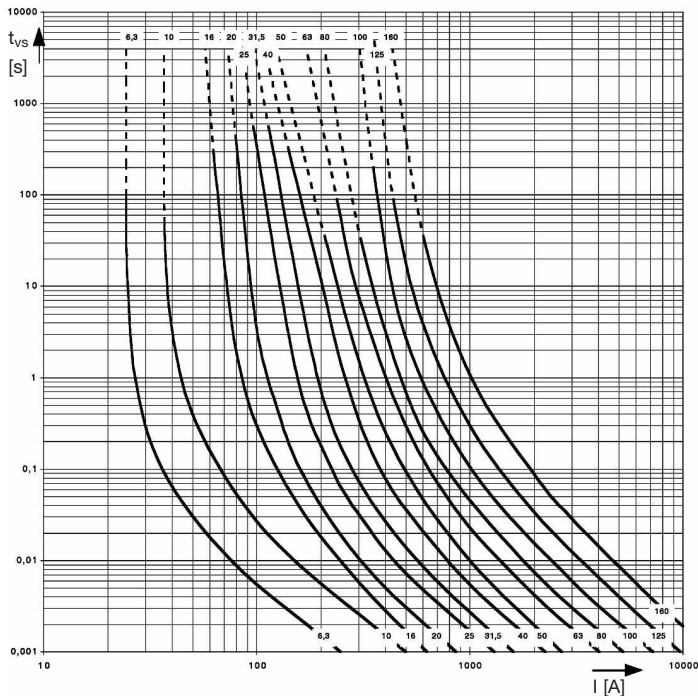

Fig.10
3/7,2 kV

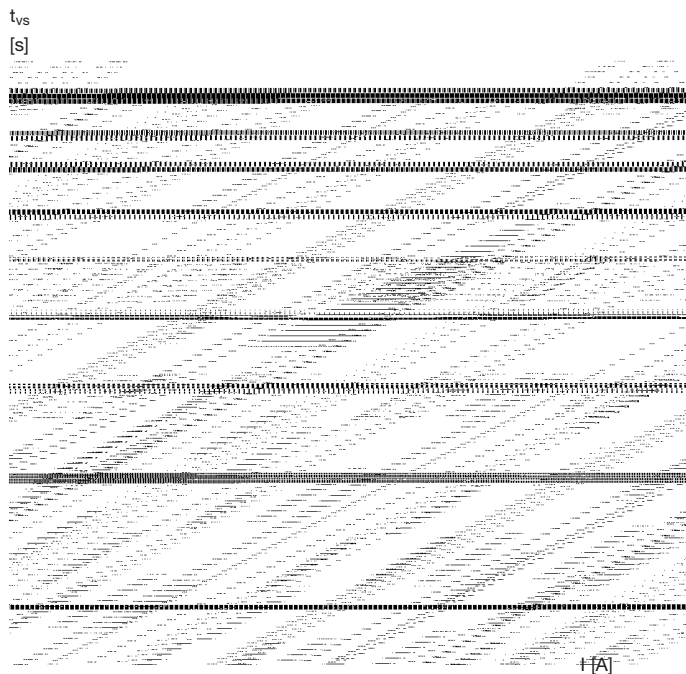

Fig. 11
6/12 kV

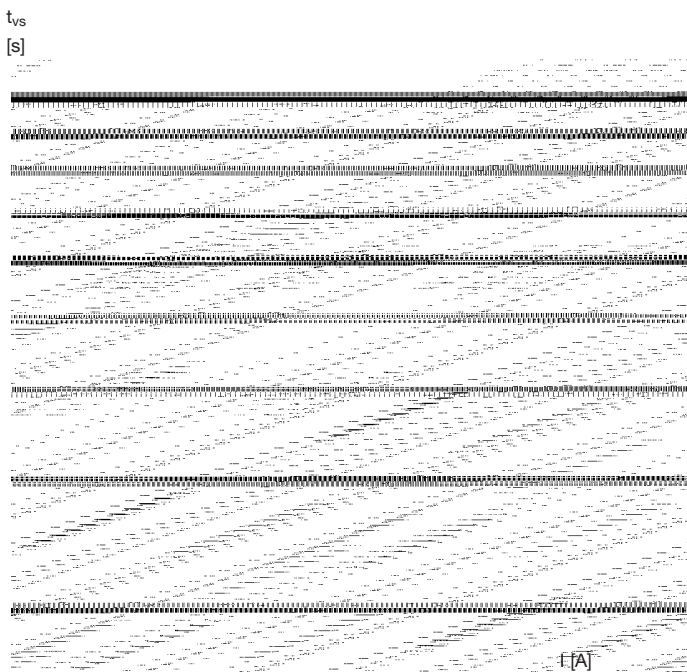

Fig. 12
10/24 kV 6,3 A-40 A

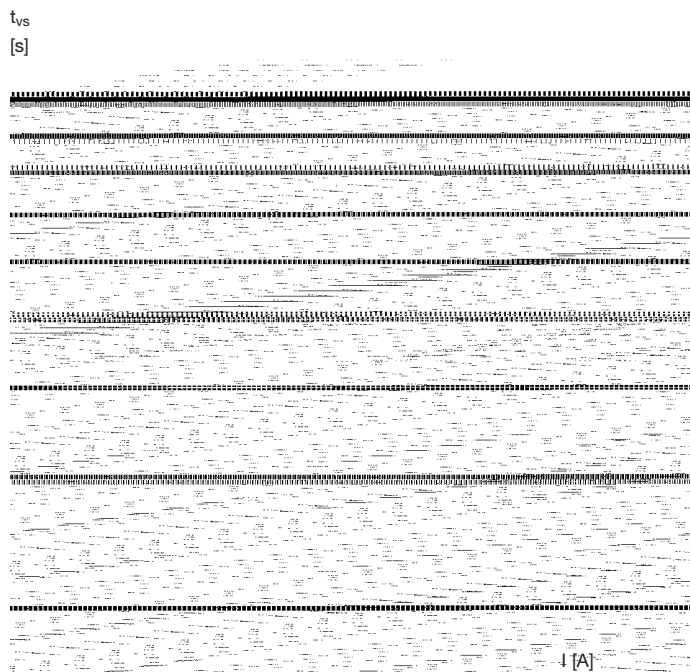

Fig. 13
10/24 kV 50 A-100 A

HV back-up Fuse-Links acc. to VDE 0670 T402 and T402 ÜLA

Time current characteristics

Dimensions acc. to DIN 43 625 in mm

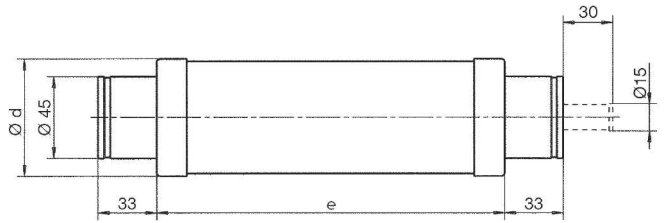
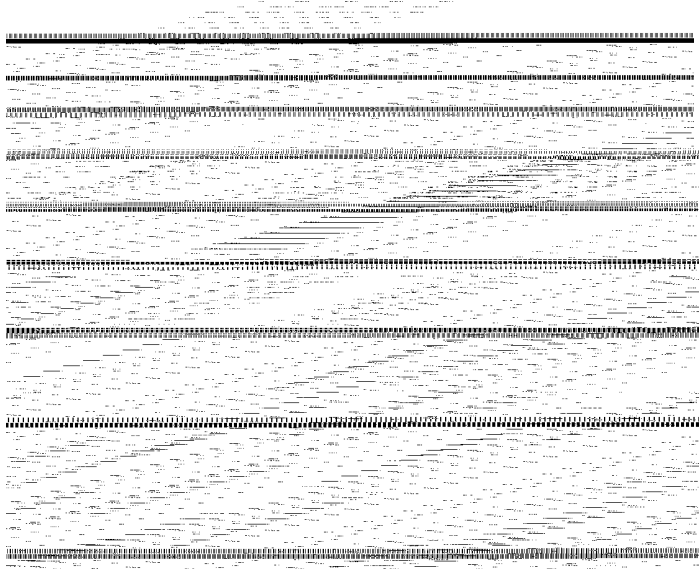

Fig. 14
20/36 kV

HV back-up Fuse-Links acc. to VDE 0670 T402/IEC 60 282-1 with ÜLA

Electrical data, dimensions, weights

Table 10

Order no.	Rated voltage range	Rated current	Rated maximum breaking current	Rated minimum breaking current	Dimensions		Resistances and power dissipation		Total I ² t	Weight	Pack
	U _N kV	I _N A	I ₁ kA	I ₃ A	e mm	d mm	R _{kalt} mΩ	P _{warm} * W	A ² s	kg	
67520-0100	6/12	10	63	35	292	56	227	29	3.000	1,6	1
67520-0160	6/12	16	63	64	292	56	66	21	3.700	1,6	1
67520-0200	6/12	20	63	90	292	56	51	25	4.700	1,6	1
67520-0250	6/12	25	63	95	292	56	40	29	4.920	1,6	1
67520-0320	6/12	31,5	63	110	292	56	30	39	7.000	1,6	1
67520-0400	6/12	40	63	134	292	56	20	46	14.000	1,6	1
67520-0500	6/12	50	63	190	292	56	15	62	25.300	1,6	1
67520-0630	6/12	63	63	220	292	65	12	62	63.000	2,1	1
67520-0800	6/12	80	63	345	292	65	8,7	85	87.000	2,1	1
67520-1000	6/12	100	63	500	292	65	8,1	152	140.000	2,1	1
67520-1250	6/12	125	63	480	292	88	4,5	117	430.000	3,7	1
67520-1600	6/12	160	63	610	292	88	4,0	175	670.000	3,7	1
67541-0060	10/24	6,3	63	23	442	56	640	31	800	2,3	1
67541-0100	10/24	10	63	36	442	56	386	48	2.000	2,3	1
67541-0160	10/24	16	63	73	442	56	127	42	2.340	2,3	1
67541-0200	10/24	20	63	91	442	56	97	53	3.900	2,3	1
67541-0250	10/24	25	63	116	442	56	73	60	6.500	2,3	1
67541-0320	10/24	31,5	63	125	442	56	57	84	7.000	2,3	1
67541-0400	10/24	40	63	161	442	56	41	96	14.200	2,3	1
67541-0500	10/24	50	63	230	442	65	35	146	24.200	3,1	1
67541-0630	10/24	63	63	350	442	65	24	163	46.400	3,1	1
67541-0800	10/24	80	63	460	442	65	19	196	104.000	3,1	1
67541-1000	10/24	100	63	420	442	88	14	279	140.000	4,1	1
67550-0060	20/36	6,3	31,5	23	537	56	889	39	600	2,7	1
67550-0100	20/36	10	31,5	34	537	56	529	66	2.000	2,7	1
67550-0160	20/36	16	31,5	70	537	56	190	67	2.340	2,7	1
67550-0200	20/36	20	31,5	100	537	56	153	84	3.900	2,7	1
67550-0250	20/36	25	31,5	110	537	56	118	100	6.500	2,7	1
67550-0320	20/36	31,5	31,5	135	537	65	82	119	7.000	3,7	1
67550-0400	20/36	40	20	205	537	65	63	176	14.200	3,7	1
67550-0500	20/36	50	20	220	537	88	41	783	40.000	6,5	1

 * Power dissipation P_{warm} at rated current of the HV Fuse-Link; power dissipation at transformer rated current in Tab. 3

HV back-up Fuse-Links acc. to VDE 0670 T4/IEC 60 282-1 with ÜLA

Table 11

Electrical data, dimensions, weights

Order no.	Rated voltage range	Rated current	Rated maximum breaking current	Rated minimum breaking current	Dimensions		Resistances and power dissipation		Total I ² t	Weight	Pack
	U _N kV	I _N A	I ₁ kA	I _s A	e mm	d mm	R _{kalt} mΩ	P _{warm} * W	A ² s	kg	
67210-0020	3/7,2	2	63	15	192	56	290	1,8	600	1,1	1
67210-0040	3/7,2	4	63	20	192	56	270	5	800	1,1	1
67110-0060	3/7,2	6,3	63	21	192	56	256	11	800	1,1	1
67110-0100	3/7,2	10	63	38	192	56	144	19	3.000	1,1	1
67110-0160	3/7,2	16	63	65	192	56	41	13	2.340	1,1	1
67110-0200	3/7,2	20	63	92	192	56	32	14,5	3.900	1,1	1
67110-0250	3/7,2	25	63	110	192	56	25	20	4.900	1,1	1
67110-0320	3/7,2	31,5	63	123	192	56	19	23	7.000	1,1	1
67110-0400	3/7,2	40	63	140	192	56	12,3	30	14.000	1,1	1
67110-0500	3/7,2	50	63	194	192	56	9,3	35	25.300	1,1	1
67210-0630	3/7,2	63	63	220	192	65	8,75	60	41.200	1,4	1
67210-0800	3/7,2	80	63	306	192	65	6,3	85	84.000	1,4	1
67210-1000	3/7,2	100	63	363	192	65	5	96	93.600	1,4	1
67110-1250	3/7,2	125	63	440	192	88	2,9	75	440.000	2,4	1
67210-1600	3/7,2	160	63	509	192	88	2,5	120	500.000	2,4	1
67210-2000	3/7,2	200	63	612	192	88	2,3	200	654.000	2,4	1
67220-0010	6/12	1	63	14	292	56	1500	1,6	90	1,6	1
67220-0020	6/12	2	63	16	292	56	510	2	280	1,6	1
67220-0040	6/12	4	63	22	292	56	338	6	500	1,6	1
67220-0060	6/12	6,3	63	30	292	56	190	8	600	1,6	1
67220-0100	6/12	10	63	42	292	56	139	16	1.150	1,6	1
67220-0160	6/12	16	63	54	292	56	107	38	1.290	1,6	1
67220-0200	6/12	20	63	73	292	56	71	38	3.200	1,6	1
67220-0250	6/12	25	63	93	292	56	52	46	5.200	1,6	1
67220-0320	6/12	31,5	63	105	292	56	43	65	7.200	1,6	1
67220-0400	6/12	40	63	125	292	56	23	54	23.300	1,6	1
67220-0500	6/12	50	63	160	292	56	18	70	34.900	1,6	1
67220-0630	6/12	63	63	230	292	56	12	85	58.300	1,6	1
67220-0800	6/12	80	63	350	292	65	10,6	114	90.000	2,1	1
67220-1000	6/12	100	63	500	292	65	8,5	156	140.000	2,1	1
67220-1250	6/12	125	63	480	292	88	4	117	440.000	3,7	1
67220-1600	6/12	160	63	560	292	88	4,3	217	500.000	3,7	1
67220-2000	6/12	200	63	610	292	88	3,8	333	654.000	3,7	1
67220-2500	6/12	250	63	740	292	88	-	-	-	-	1
67230-0020	10/17,5	2	63	15	367	56	610	4	600	1,9	1
67230-0040	10/17,5	4	63	20	367	56	580	15	800	1,9	1
67230-0500	10/17,5	50	63	165	367	65	28	117	20.600	2,6	1
67230-0630	10/17,5	63	63	220	367	65	21	150	41.200	2,6	1
67230-0800	10/17,5	80	63	300	367	65	15	183	84.000	2,6	1
67230-1000	10/17,5	100	63	350	367	65	13	260	93.600	2,6	1
67240-0010	10/24	1	63	14	442	56	2100	2	90	2,3	1
67240-0020	10/24	2	63	16	442	56	800	3	340	2,3	1
67240-0040	10/24	4	63	23	442	56	550	10	450	2,3	1
67240-0060	10/24	6,3	63	30	442	56	300	13	530	2,3	1
67240-0100	10/24	10	63	43	442	56	220	26	940	2,3	1
67240-0160	10/24	16	63	54	442	56	197	73	1.400	2,3	1
67240-0200	10/24	20	63	73	442	56	134	76	3.100	2,3	1
67240-0250	10/24	25	63	93	442	56	96	89	4.500	2,3	1
67240-0320	10/24	31,5	63	105	442	56	79	127	5.900	2,3	1
67240-0400	10/24	40	63	125	442	56	45	114	18.800	2,3	1
67240-0500	10/24	50	63	205	442	56	35	147	33.500	2,3	1
67240-0630	10/24	63	63	280	442	65	25	163	46.400	2,3	1
67240-0800	10/24	80	63	310	442	65	20,5	233	84.000	3,1	1
67240-1000	10/24	100	63	430	442	78	18	400	93.600	4,1	1
67240-1250	10/24	125	40	760	442	88	11	340	350.000	5,9	1
67240-1600	10/24	160	31,5	900	442	88	9,6	515	500.000	5,9	1
67240-2000	10/24	200	31,5	1050	442	88	7,4	740	730.000	5,9	1

Order no.	Rated voltage range	Rated current I_N A	Rated maximum breaking current I_1 kA	Rated minimum breaking current I_3 A	Dimensions		Resistances and power dissipation		Total I^2t A ² s	Weight kg	Pack
	U_N kV				e mm	d mm	R_{kalt} m Ω	P_{warm}^* W			
67250-0020	20/36	2	31,5	15	537	56	950	9	600	2,7	1
67250-0040	20/36	4	31,5	20	537	56	900	32	800	2,7	1
67150-0060	20/36	6,3	31,5	23	537	56	827	39	600	2,7	1
67150-0100	20/36	10	31,5	34	537	56	520	65	2.000	2,7	1
67150-0160	20/36	16	31,5	70	537	56	210	67	2.340	2,7	1
67150-0200	20/36	20	31,5	100	537	56	165	84	3.900	2,7	1
67150-0250	20/36	25	31,5	110	537	56	125	100	6.500	2,7	1
67150-0320	20/36	31,5	31,5	135	537	65	85	119	7.000	3,7	1
67150-0400	20/36	40	20	205	537	65	65	176	14.200	3,7	1
67150-0500	20/36	50	20	220	537	88	45	183	40.000	6,5	1
67150-0630	20/36	63	20	360	537	88	35	271	61.700	6,5	1

HV back-up Fuse-Links acc. to VDE 0670 T4 und T4 ÜLA

Time current characteristics

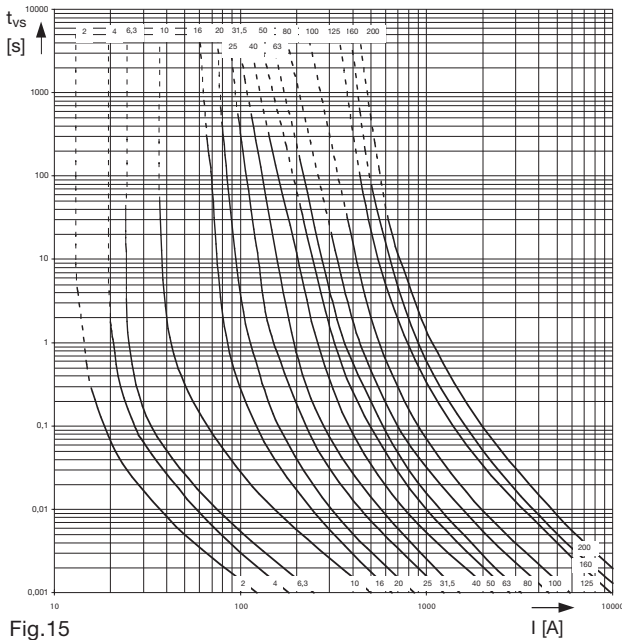

Fig.15
3/7,2 kV

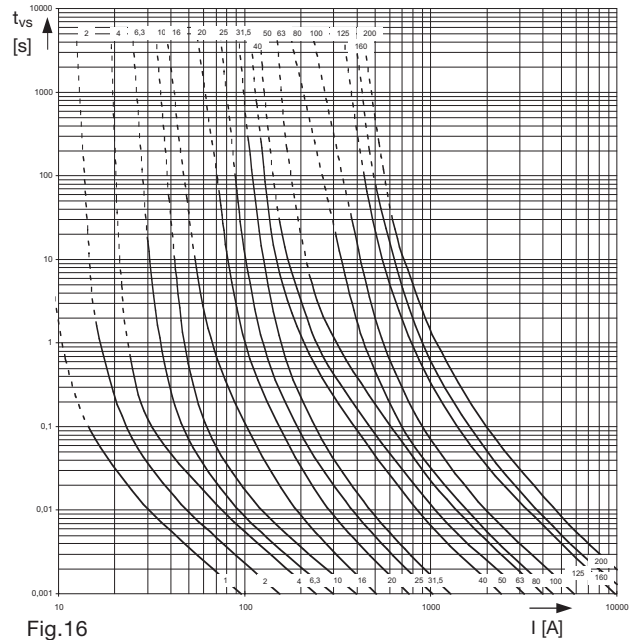

Fig.16
6/12 kV

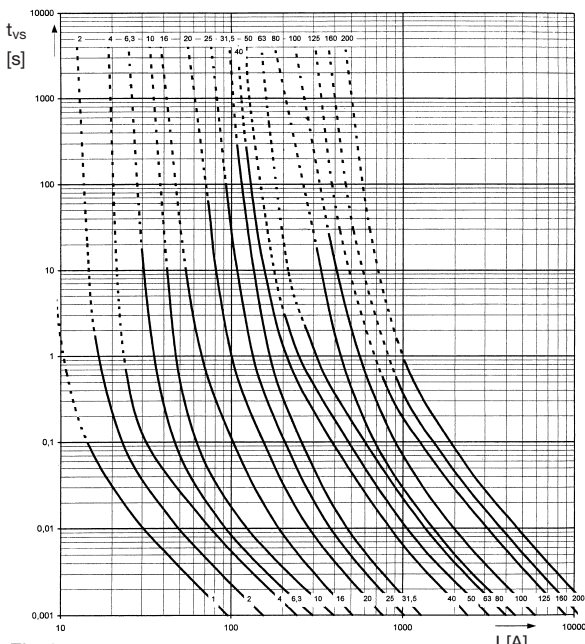

Fig.17
10/24 kV

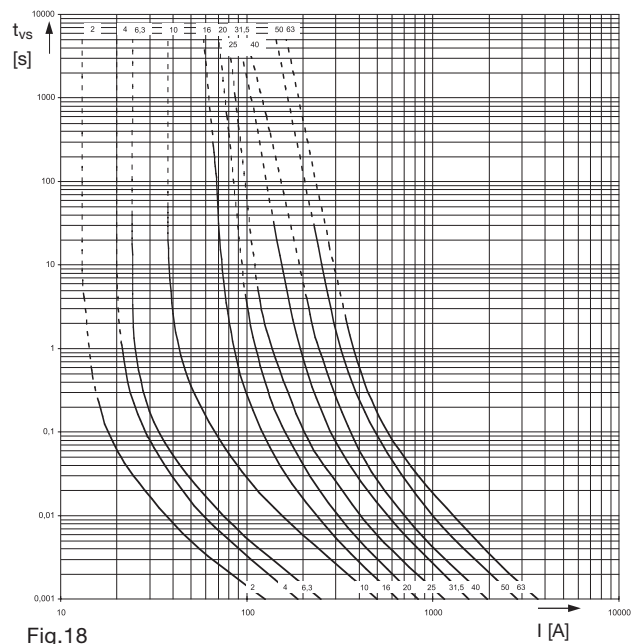

Fig.18
20/36 kV

EFEN General purpose Fuse-Links

Table 12

Electrical data, dimensions, weights

Order no.	Rated voltage range	Rated current	Rated maximum breaking current	Dimensions		Resistances and power dissipation		Total I ² t	Weight	Pack
	U _N kV			I _N A	I ₁ kA	e mm	d mm			
67420-0060	6/12	6,3	40	292	65	132	6	2.000	2,3	1
67420-0100	6/12	10	40	292	65	70	8	3.800	2,3	1
67420-0160	6/12	16	40	292	65	35	10	14.000	2,3	1
67420-0250	6/12	25	40	292	65	21	15	36.000	2,3	1
67420-0400	6/12	40	40	292	78	13	24	110.000	3,1	1
67420-0500	6/12	50	40	292	88	10	31	150.000	3,7	1
67440-0040	10/24	4	40	442	78	280	5	1.800	4,1	1
67440-0060	10/24	6,3	40	442	78	260	11	2.000	4,1	1
67440-0100	10/24	10	40	442	78	138	15	3.600	4,1	1
67440-0160	10/24	16	40	442	78	70	21	14.000	4,1	1
67440-0250	10/24	25	40	442	88	41	31	39.000	4,5	1

HV Fuse-Bases acc. to DIN 43 624 for indoor

Electrical data, dimensions, weights

Table 13

Order no.	U _N kV	I _N A	Dimensions in mm								Weight kg	Pack
			a	b	c	d	e	f	g	h		
68007-0010	12	200	293	255	195	323	425	55	453	55	3,8	1
68008-0010	24	200	443	335	275	473	575	300	603	66	4,8	1
68012-0010	36	200	538	495	435	568	700	380	698	108	9,4	1

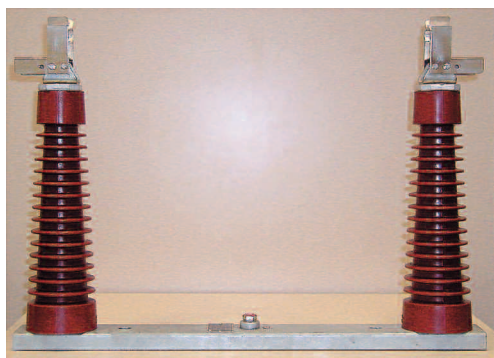
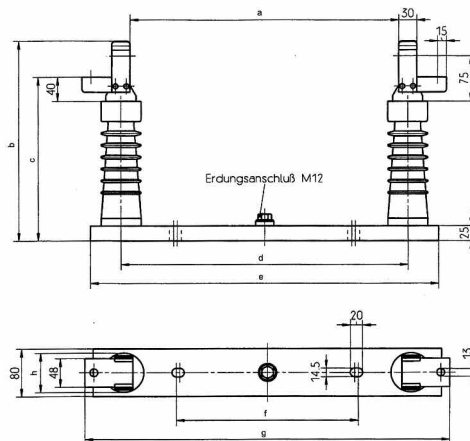

Fig. 19
HV Fuse-Base indoor 36 kV



Fuse-Base contacts, rated current 200 A

Table 14

Terminal screw M10x35
Countersunk hole M6

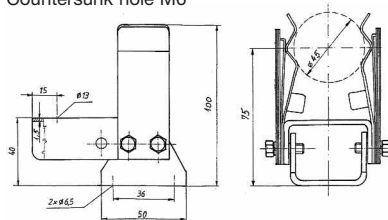

68016-0010

Application	indoor and outdoor
Contact-bow	E-Copper silver plated
Flat terminal	E-Copper tin plated
Weight	0,42 kg
Order no-	68016-0010

Application	indoor and outdoor
Contact-bow	E-Copper silver plated
Flat terminal	E-Copper tin plated
Weight	0,35 kg
Order no-	81931-0100

Adapter for HV fuses acc. to DIN 43 625

for extension of Fuse-Links from dimension e 292 mm (12 kV) to 442 mm (24 kV)

Description	Order no.	design
Adapter	68003-0100	surface silver coated
Holder	68004-0010	

Adapter

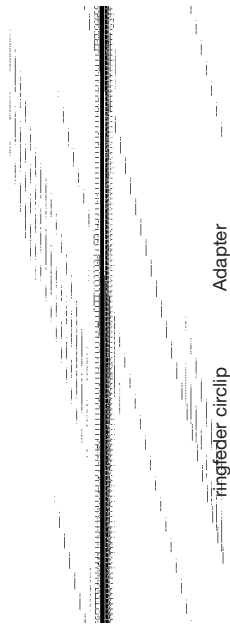

Holder

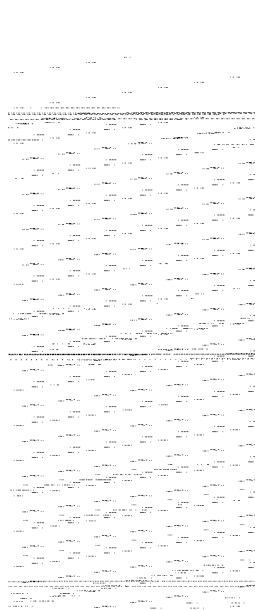

Fig. 20

Fig. 21

Test device for tripping device

Testdevice



Extension
12 kV



Extension
24 kV



Fig. 22

Description	Order no.	Dimensions			Pack
		diameter in mm	Length in mm	total dimension e in mm	
Test device 65 N 192 mm (7,2 kV)	68013-0020	67	190	190	1
Extension to 292 mm (12 kV)	68014-0010	61	100	290	1
Extension to 442 mm (24 kV)	68015-0010	61	250	440	1